

Dutch Railway Signal

Design by Mattzobricks
mattzobricks.com



Version 1.0

(c) 2022 by Matthias Runte
All rights reserved
www.mattzobricks.com
info@mattzobricks.com

1

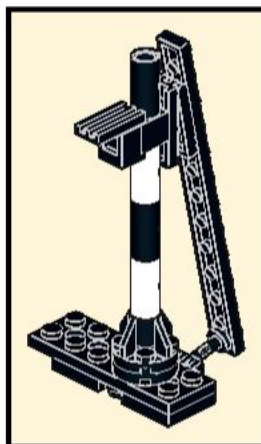
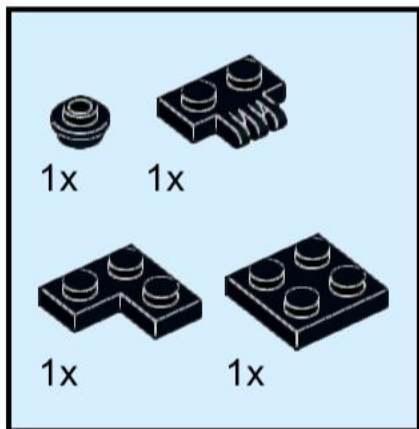

2

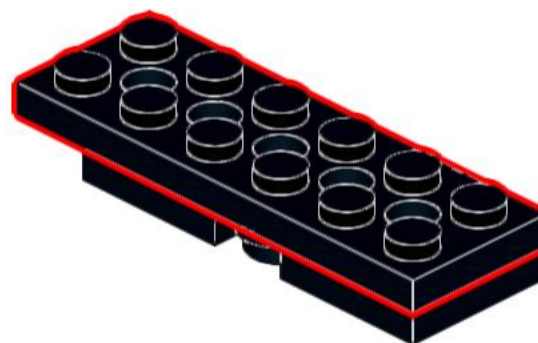
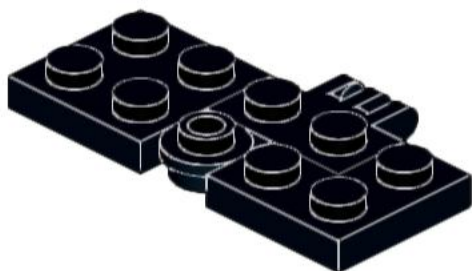
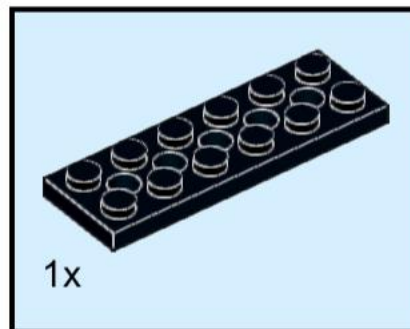

3

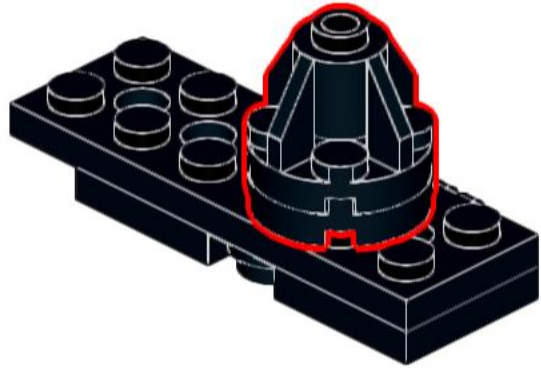
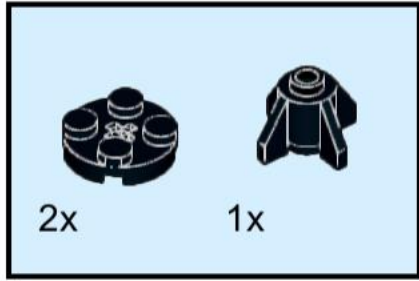

4

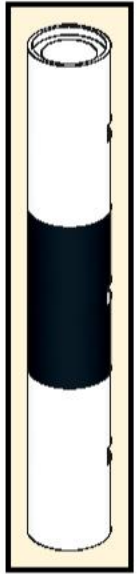
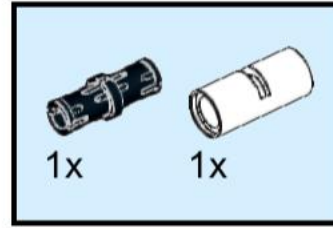

5

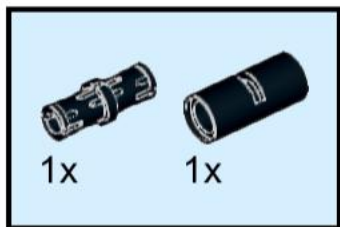

6

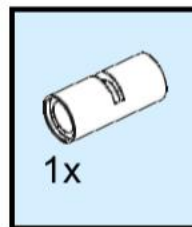

7

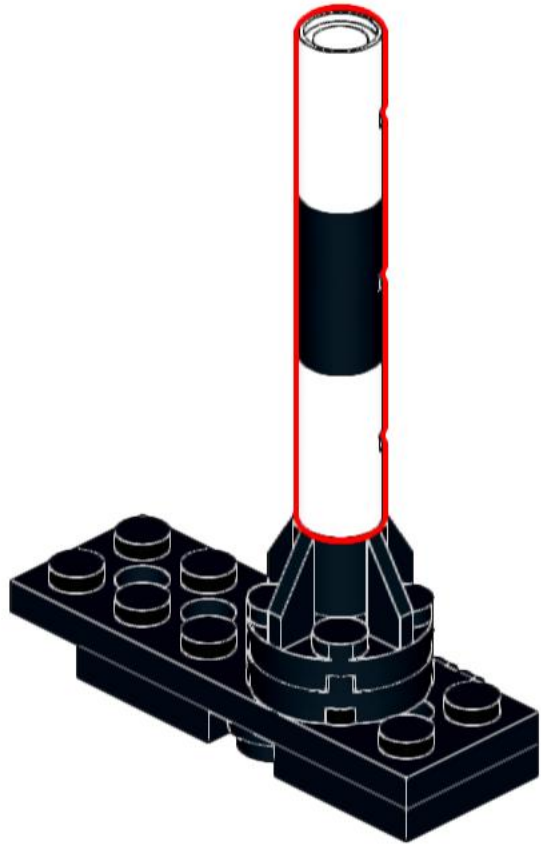

8

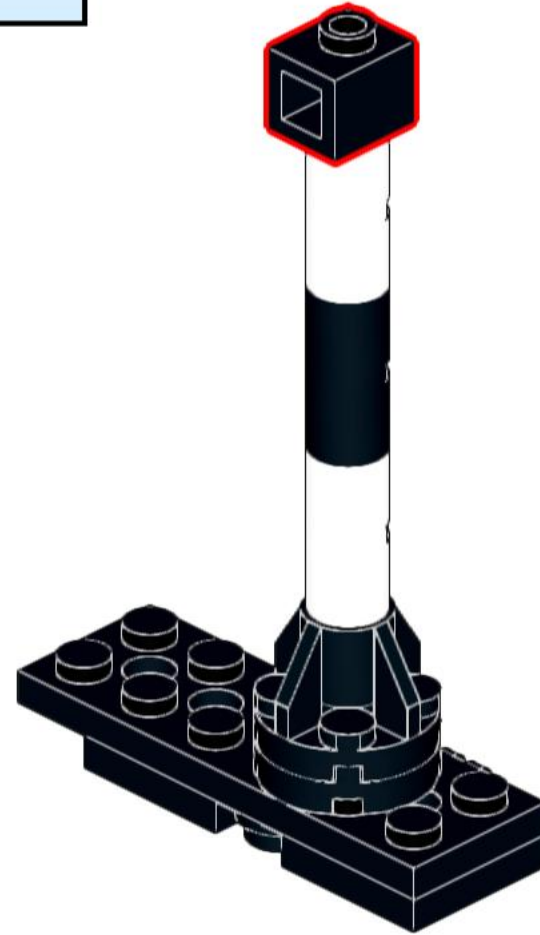

9

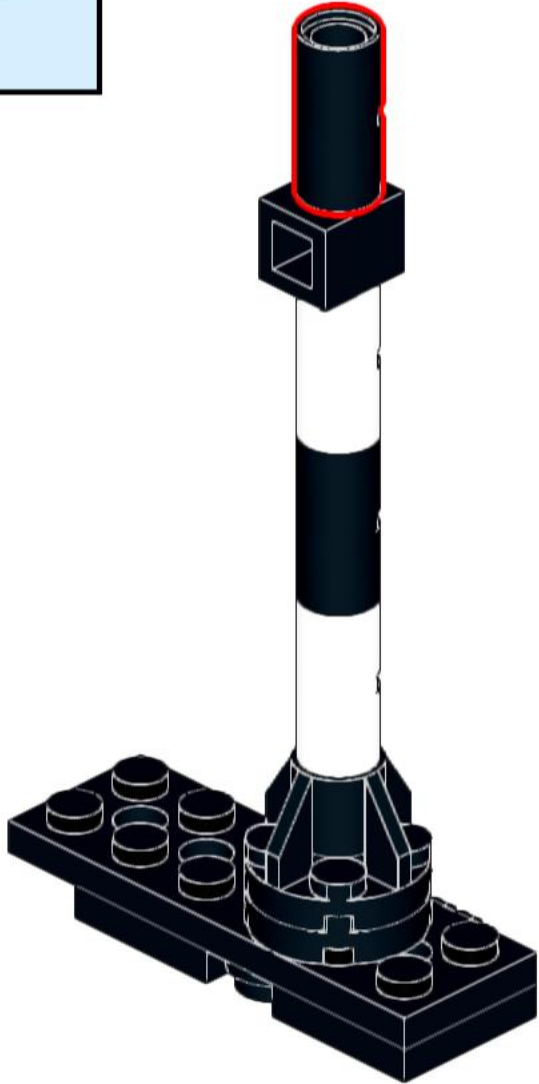
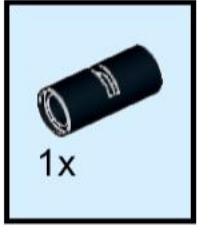

10

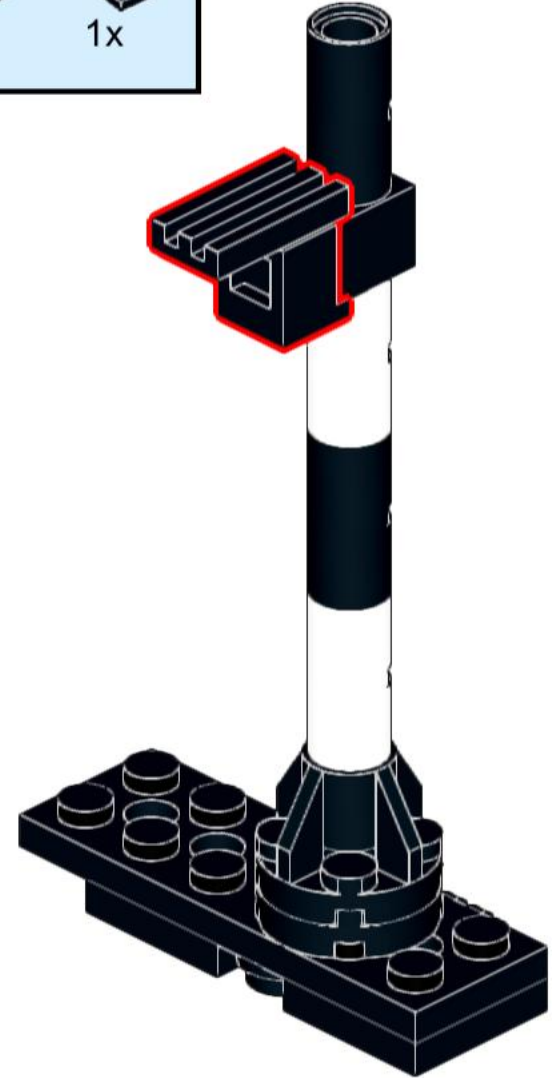
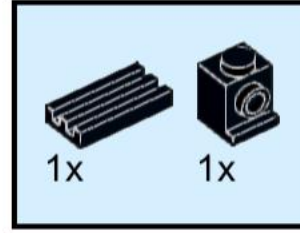

11

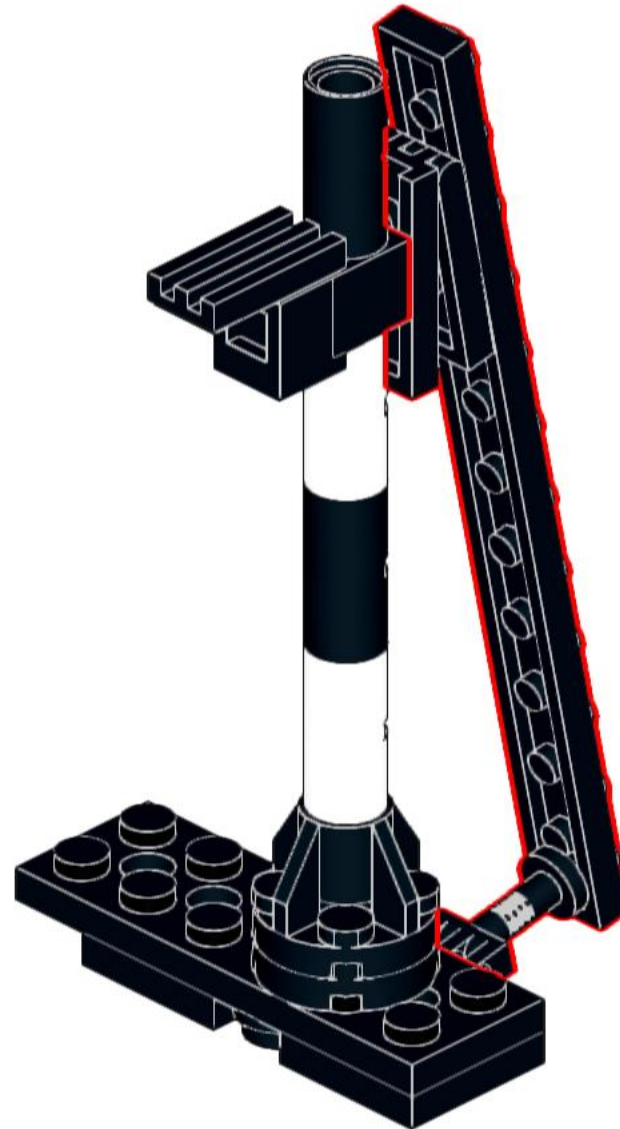
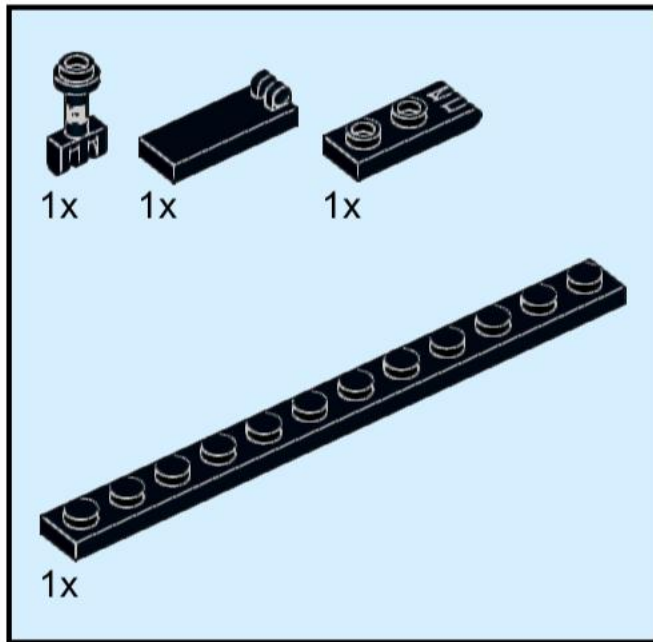

12

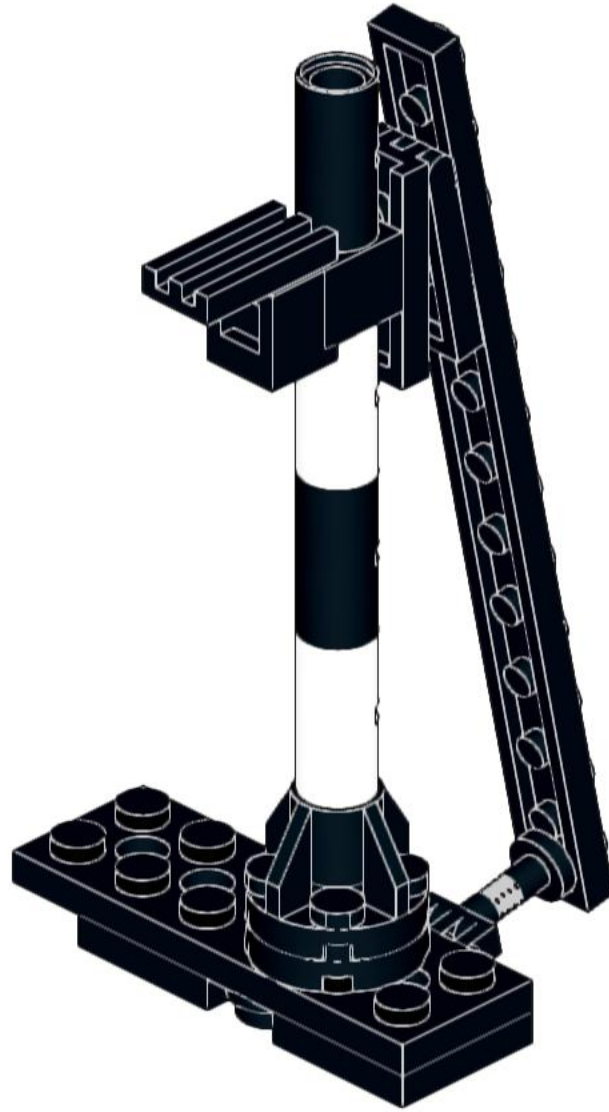

13

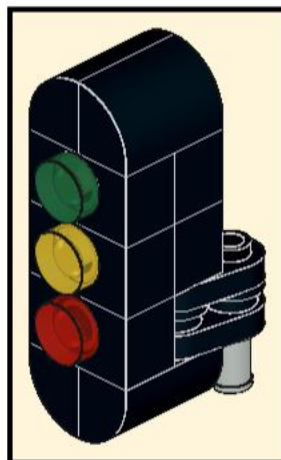
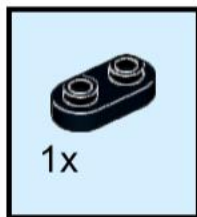

14



15

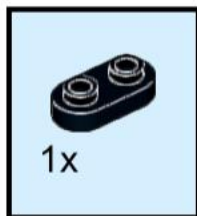

16

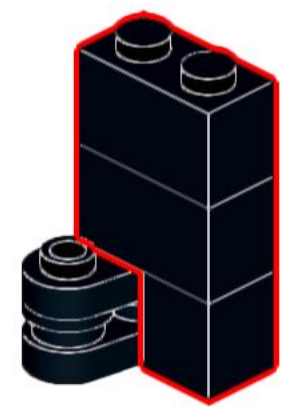
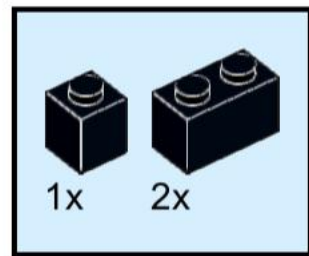

17

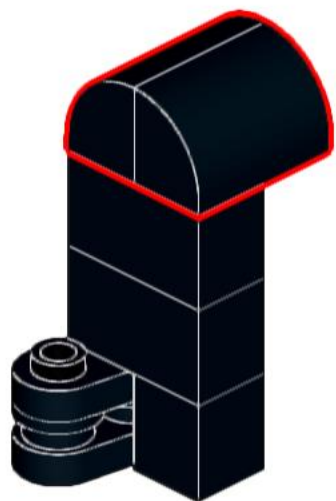
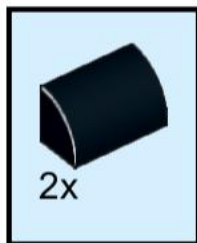

18

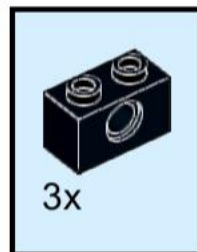

19

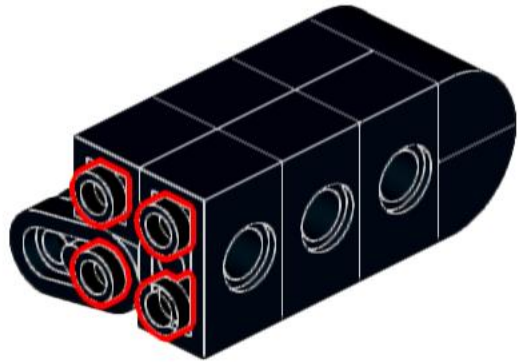

20

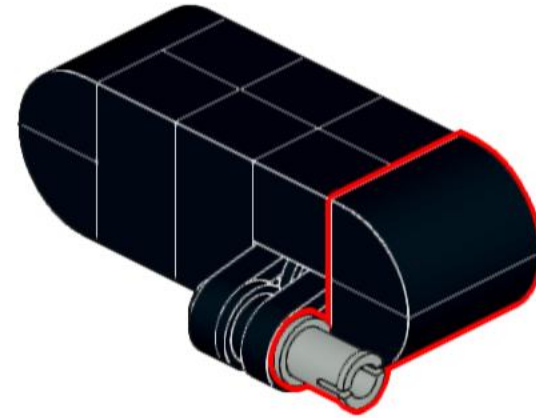
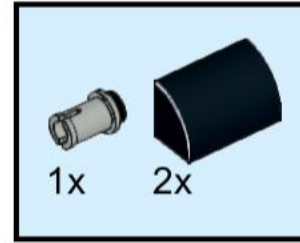

21

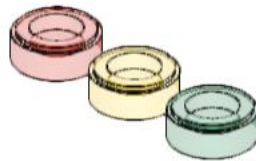
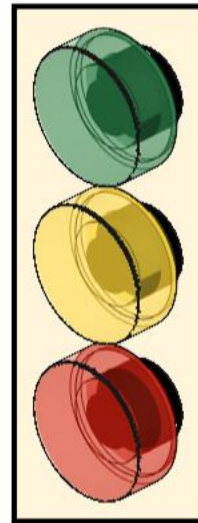
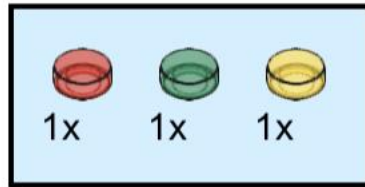

22

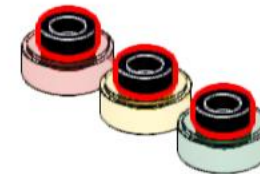

23

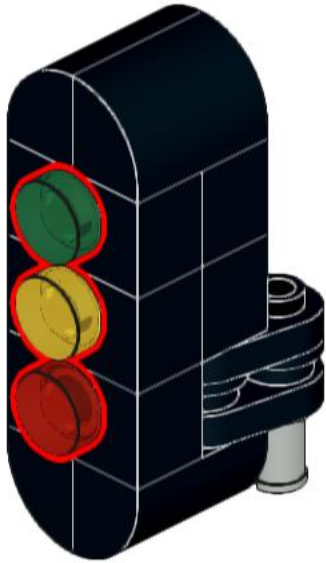

24

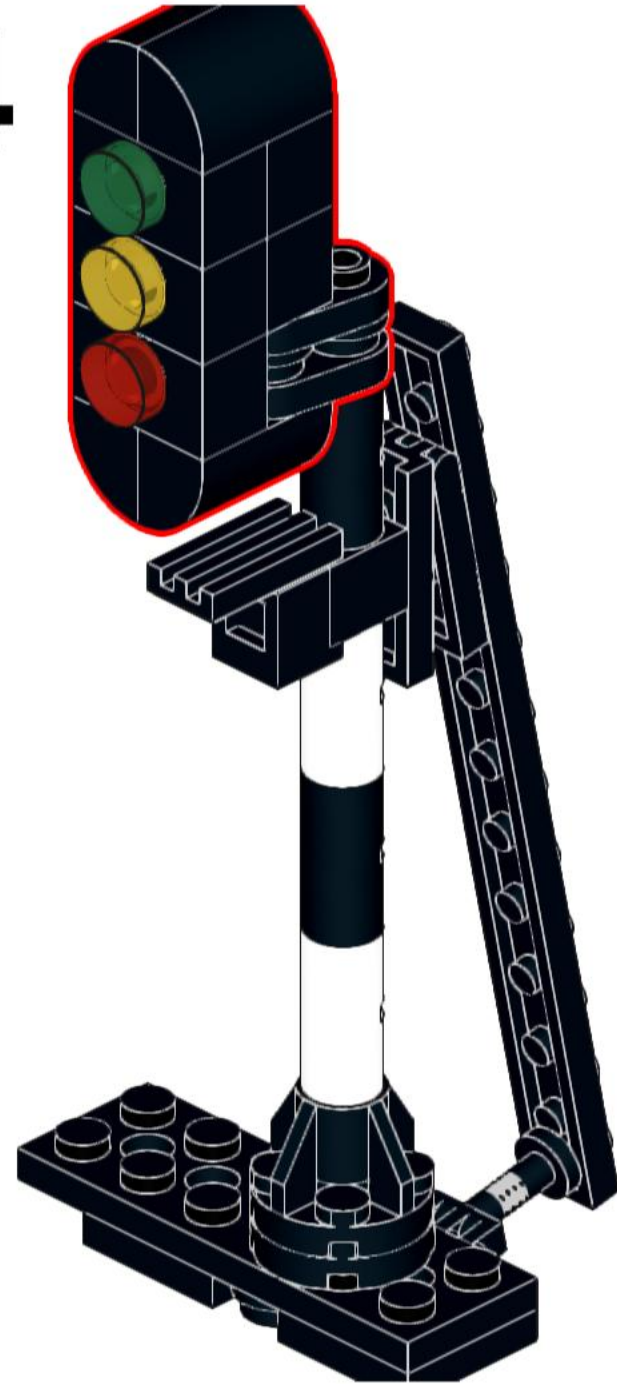

Check out information about LEGO track planning, LEGO train automation and more instructions on www.mattzobricks.com.

