

# Track Sensor for MILS - V1.0

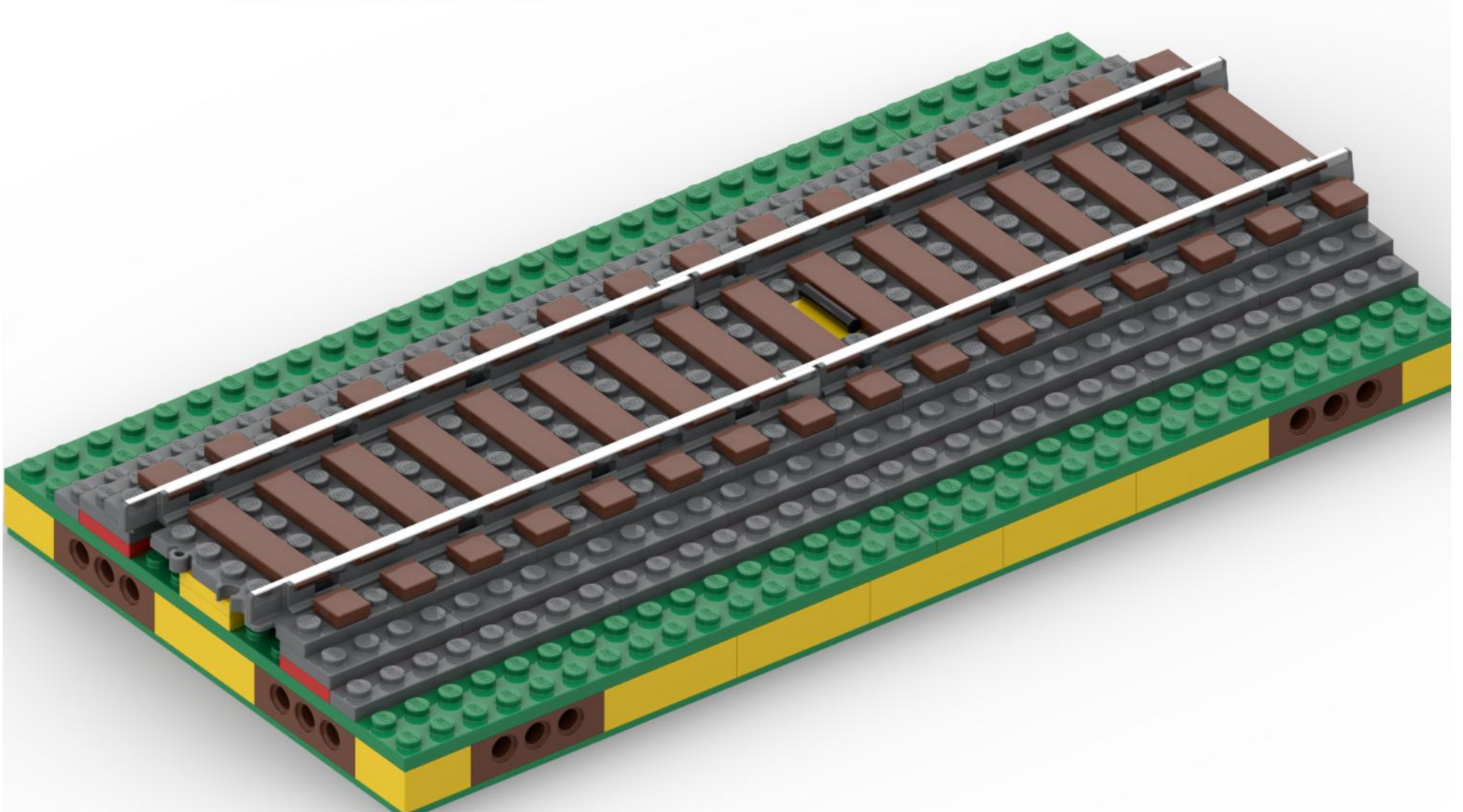

(c) 2024 by Matthias Runte. All rights reserved.  
[www.mattzobricks.com](http://www.mattzobricks.com) - [info@mattzobricks.com](mailto:info@mattzobricks.com)

1

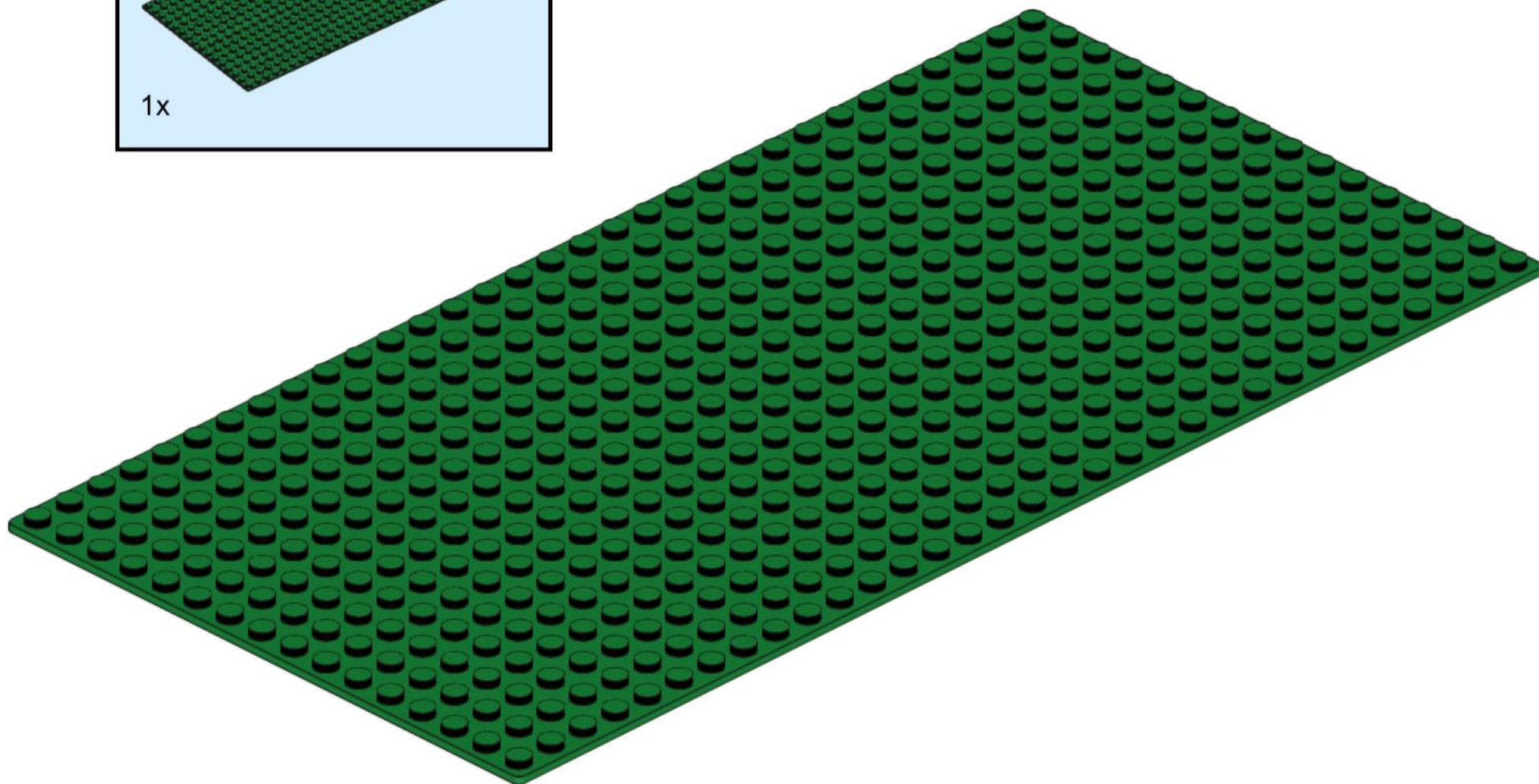
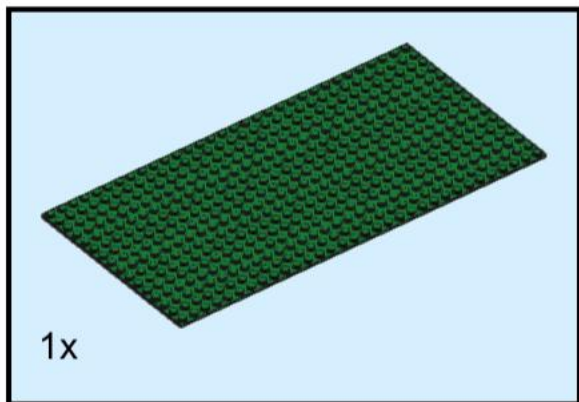

# 2

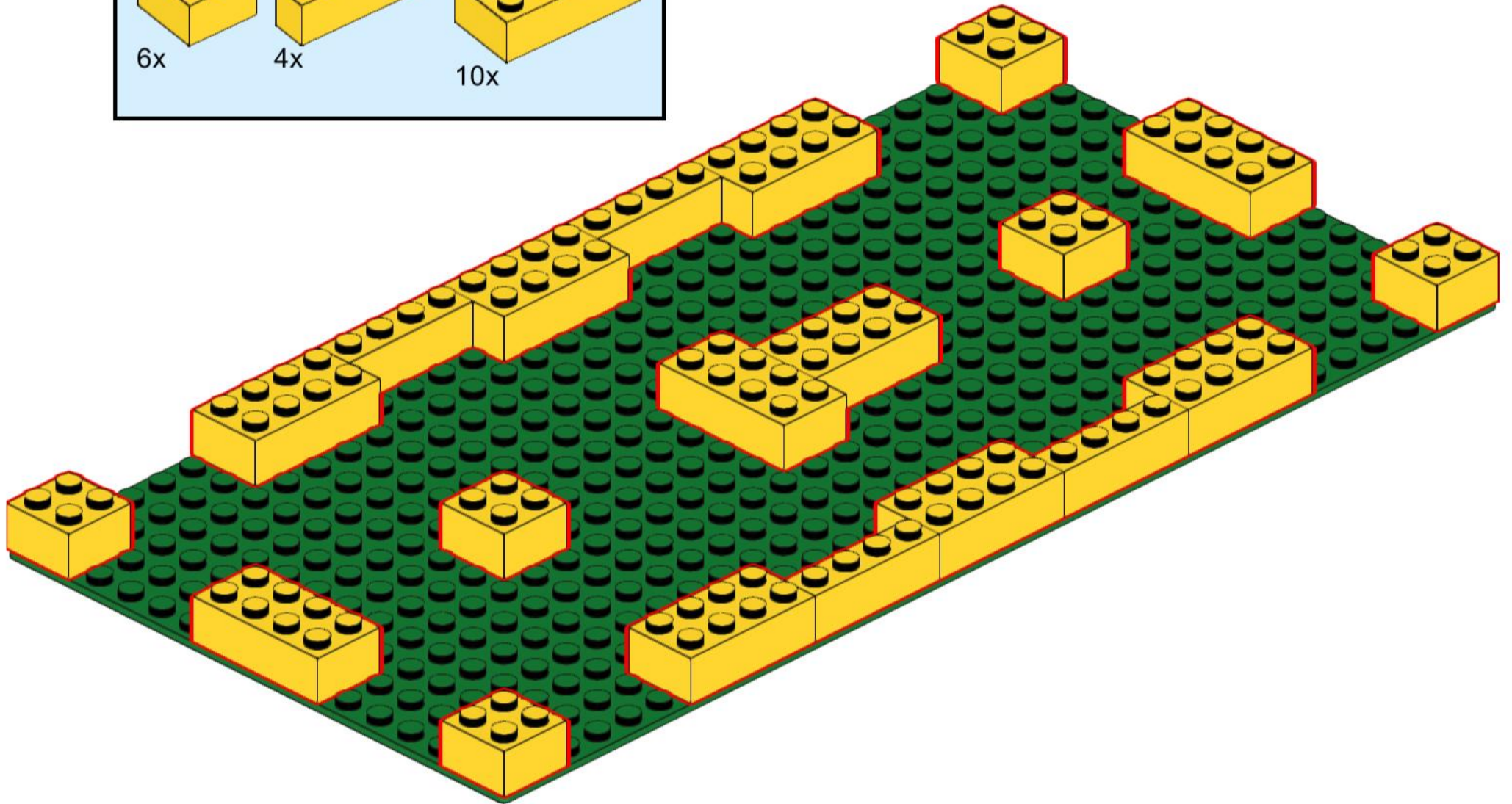
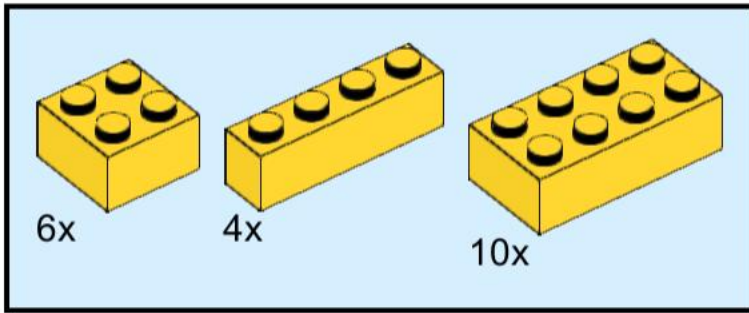

3

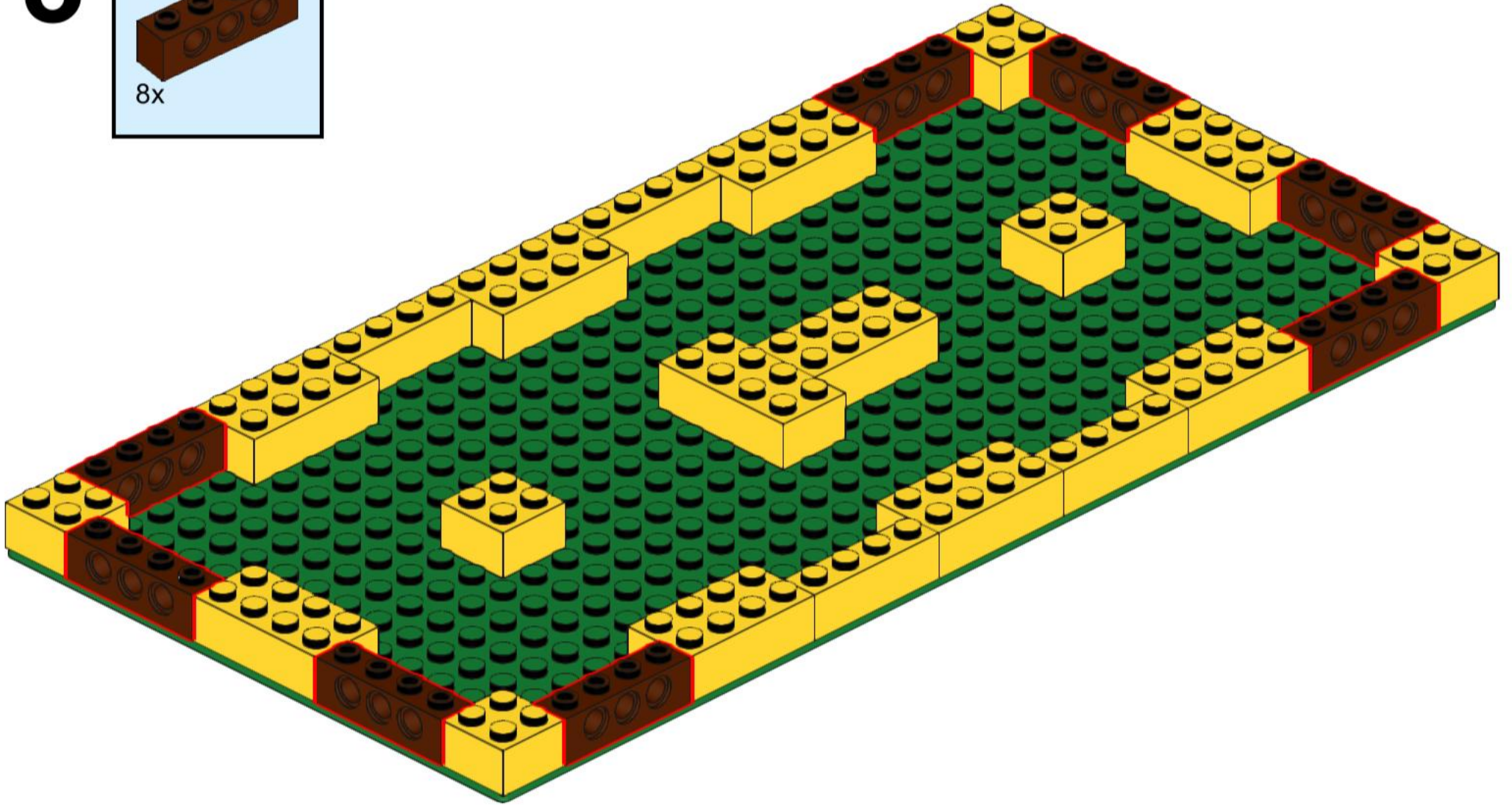
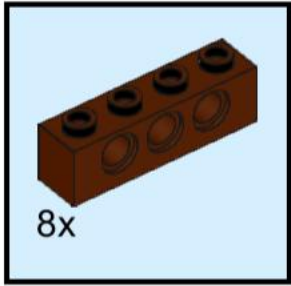

4

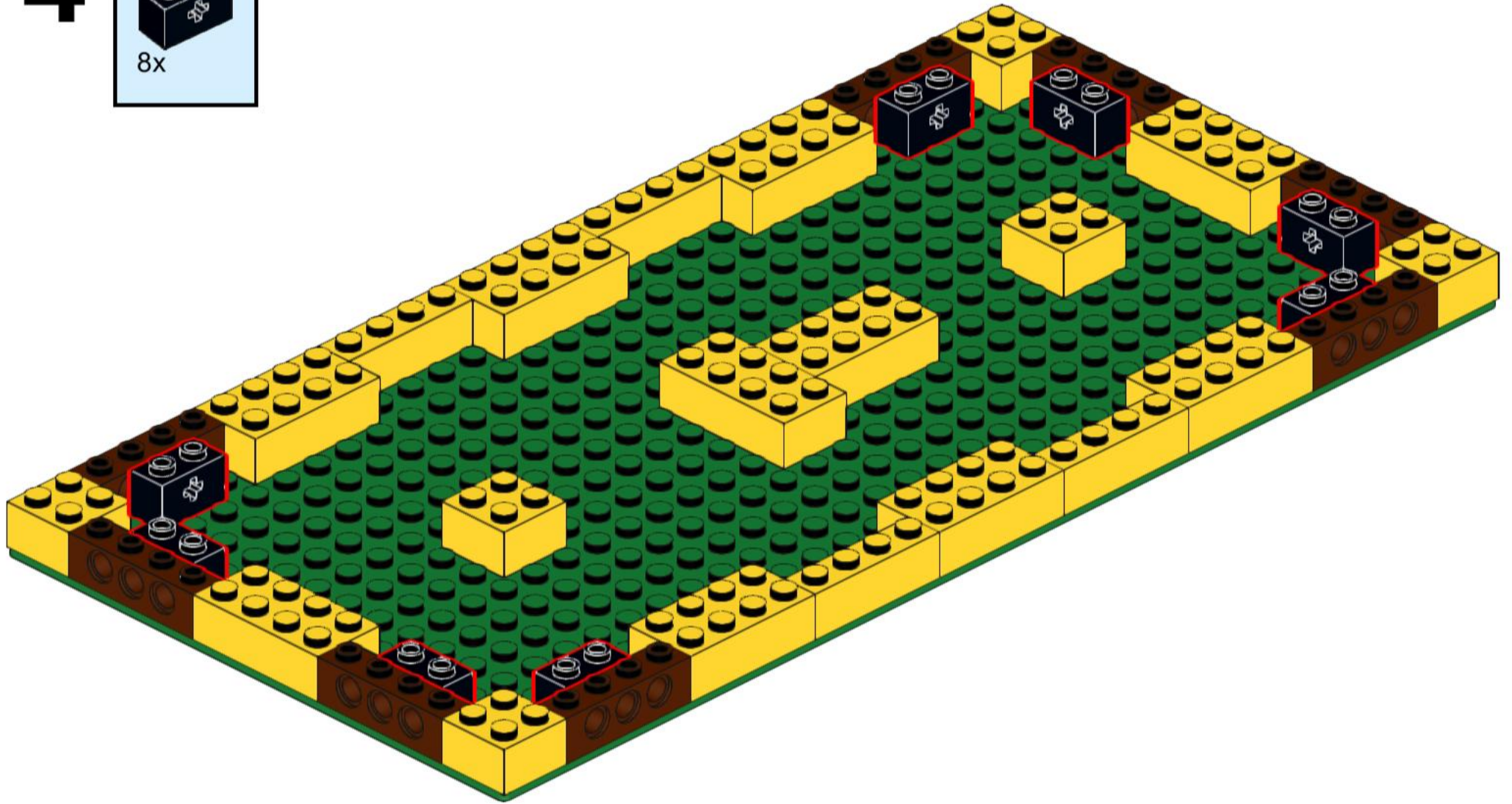
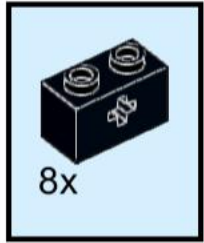

# 5

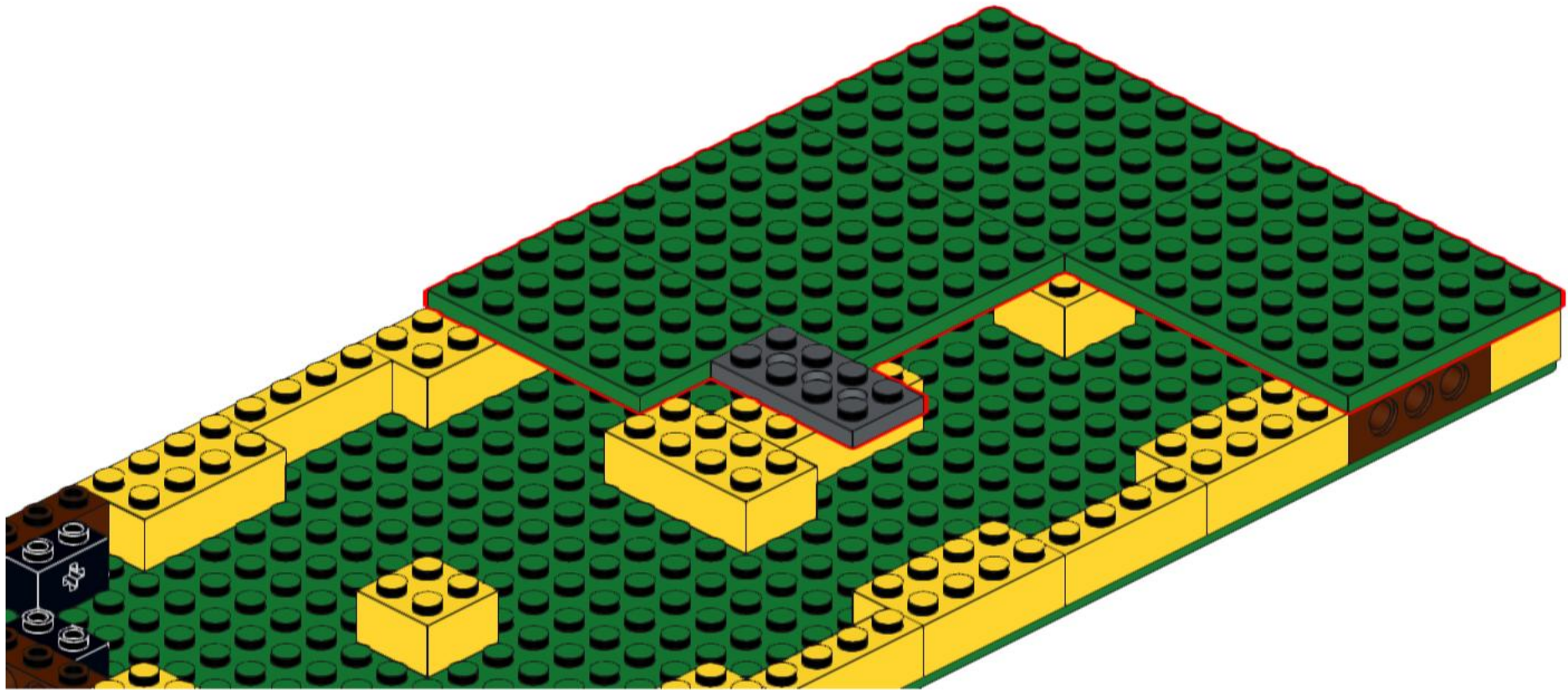
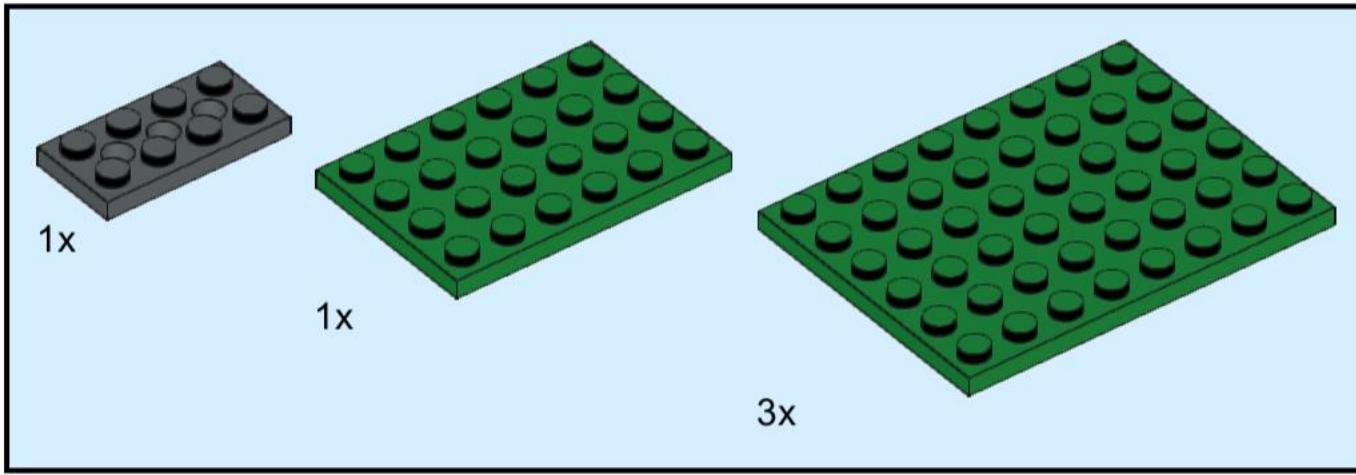

6

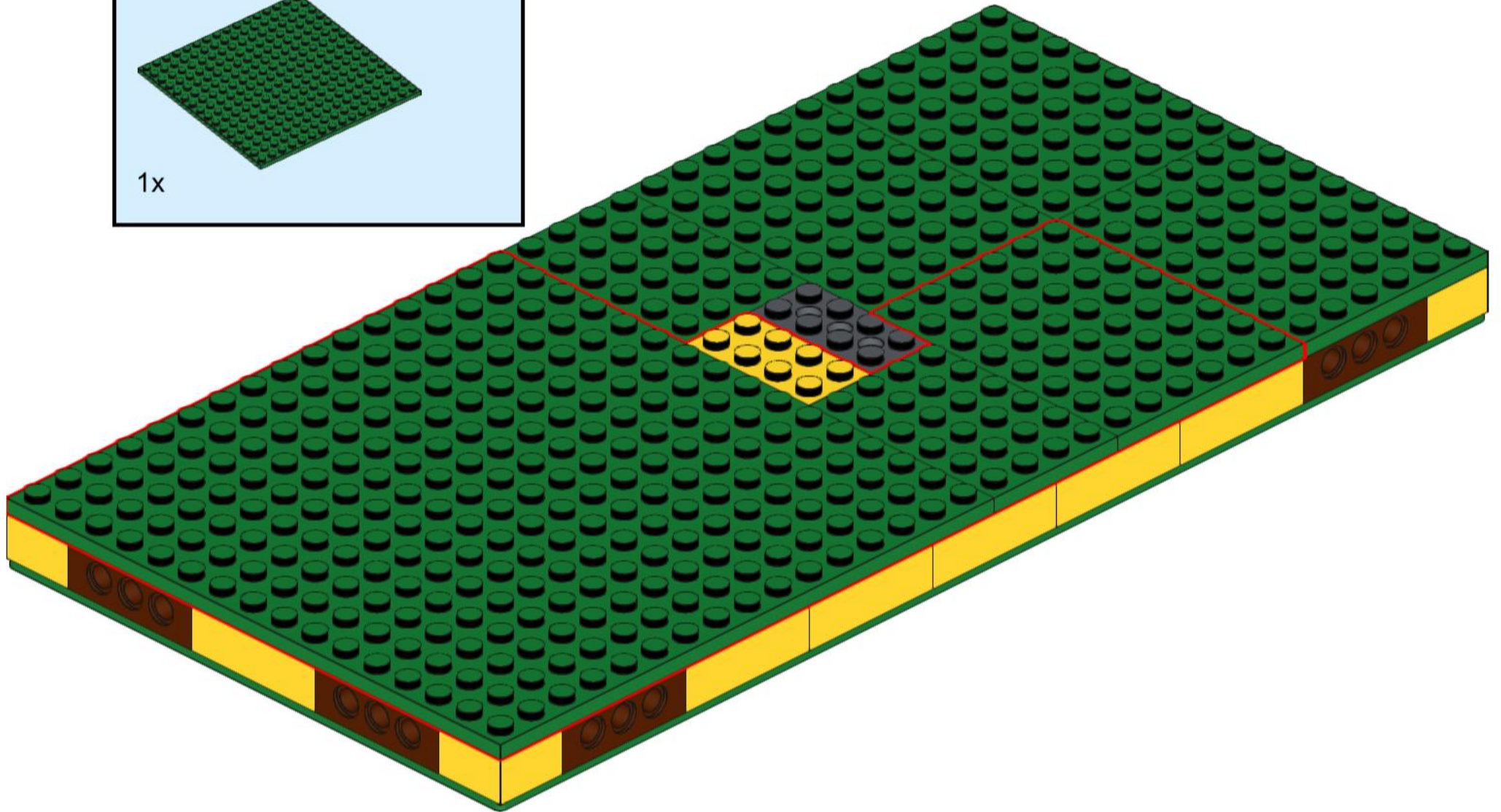
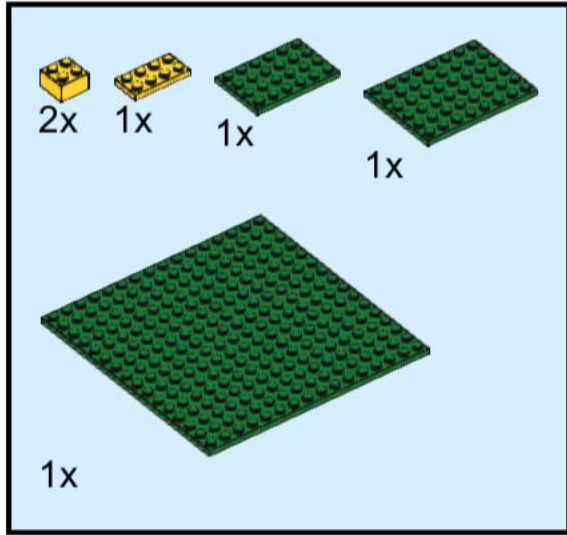

7

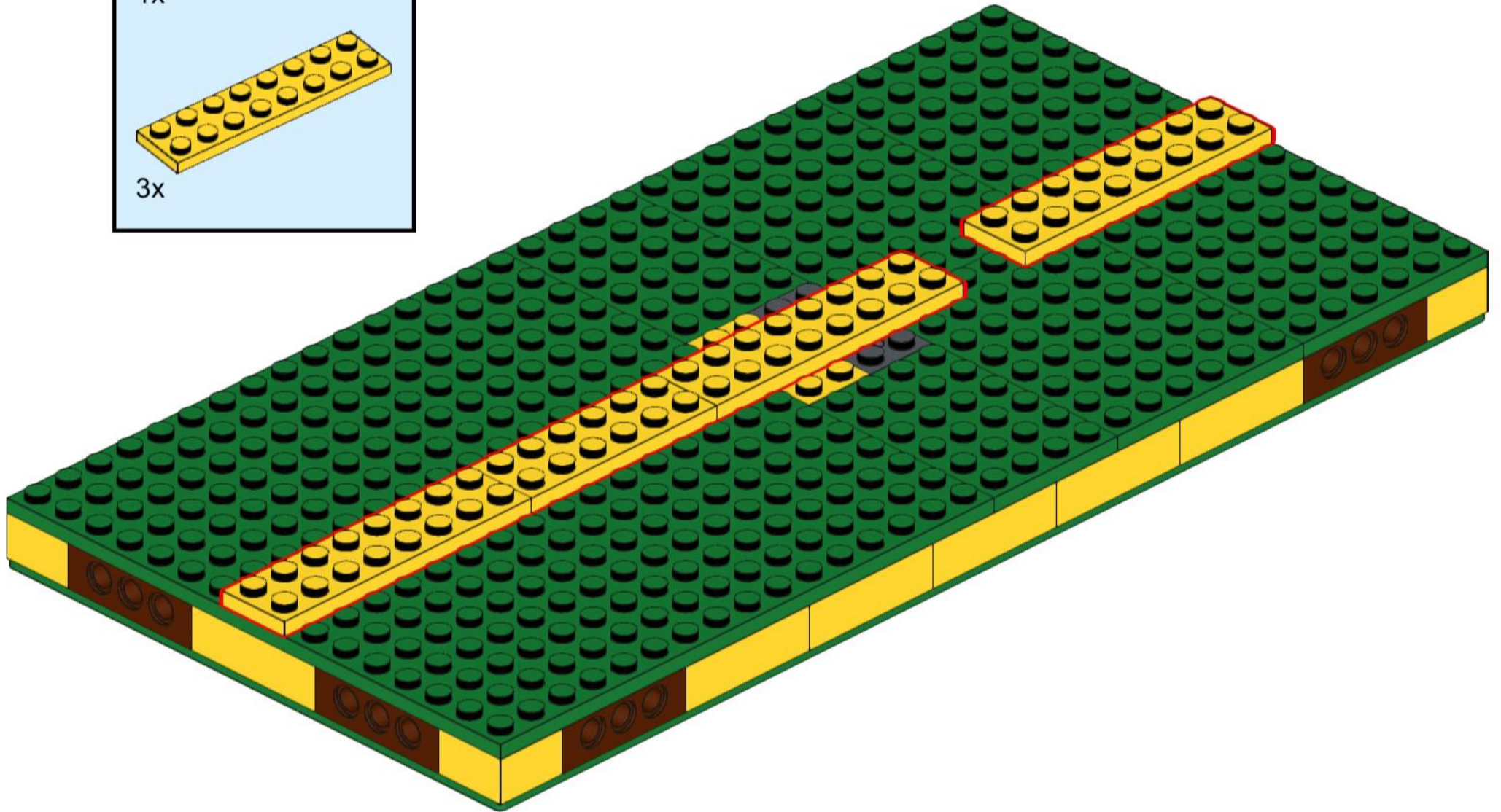
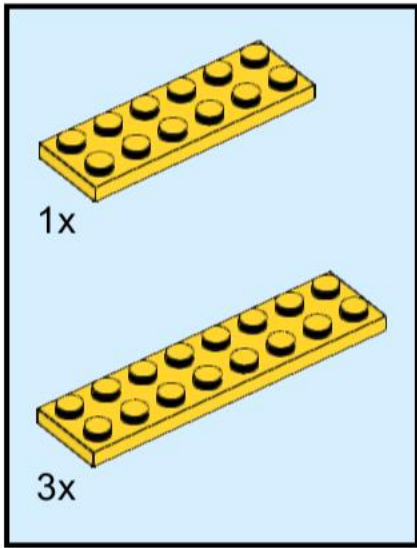



8

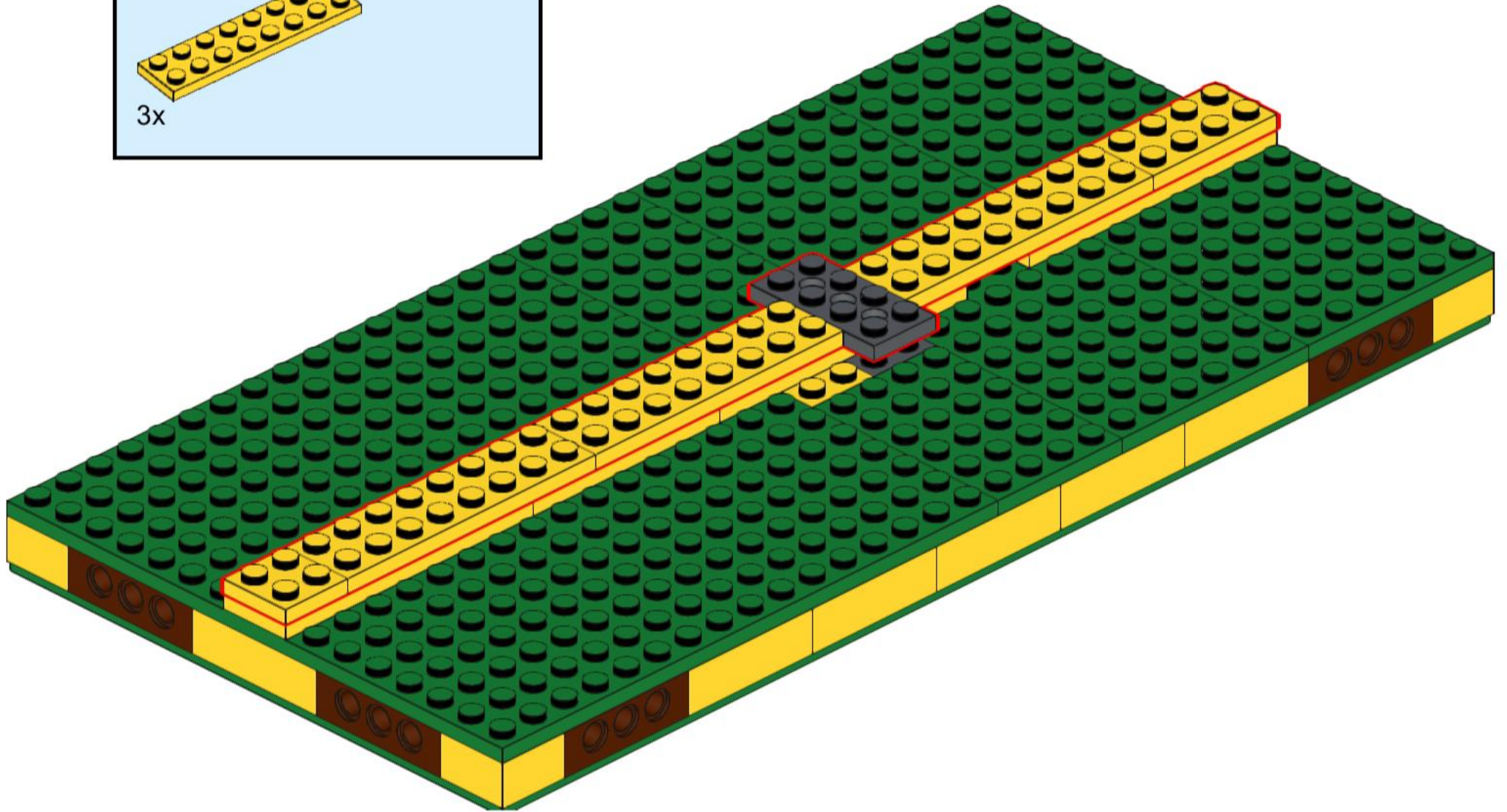
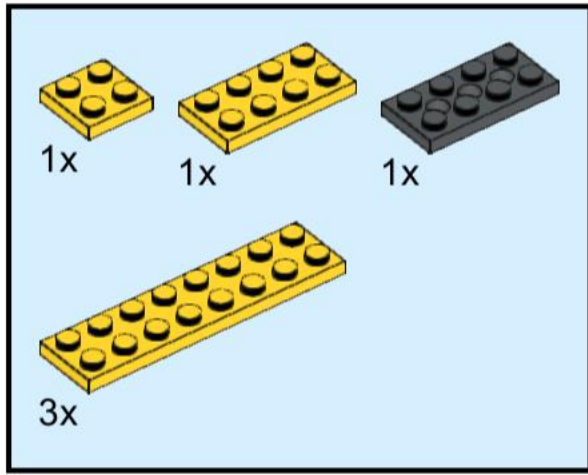

9

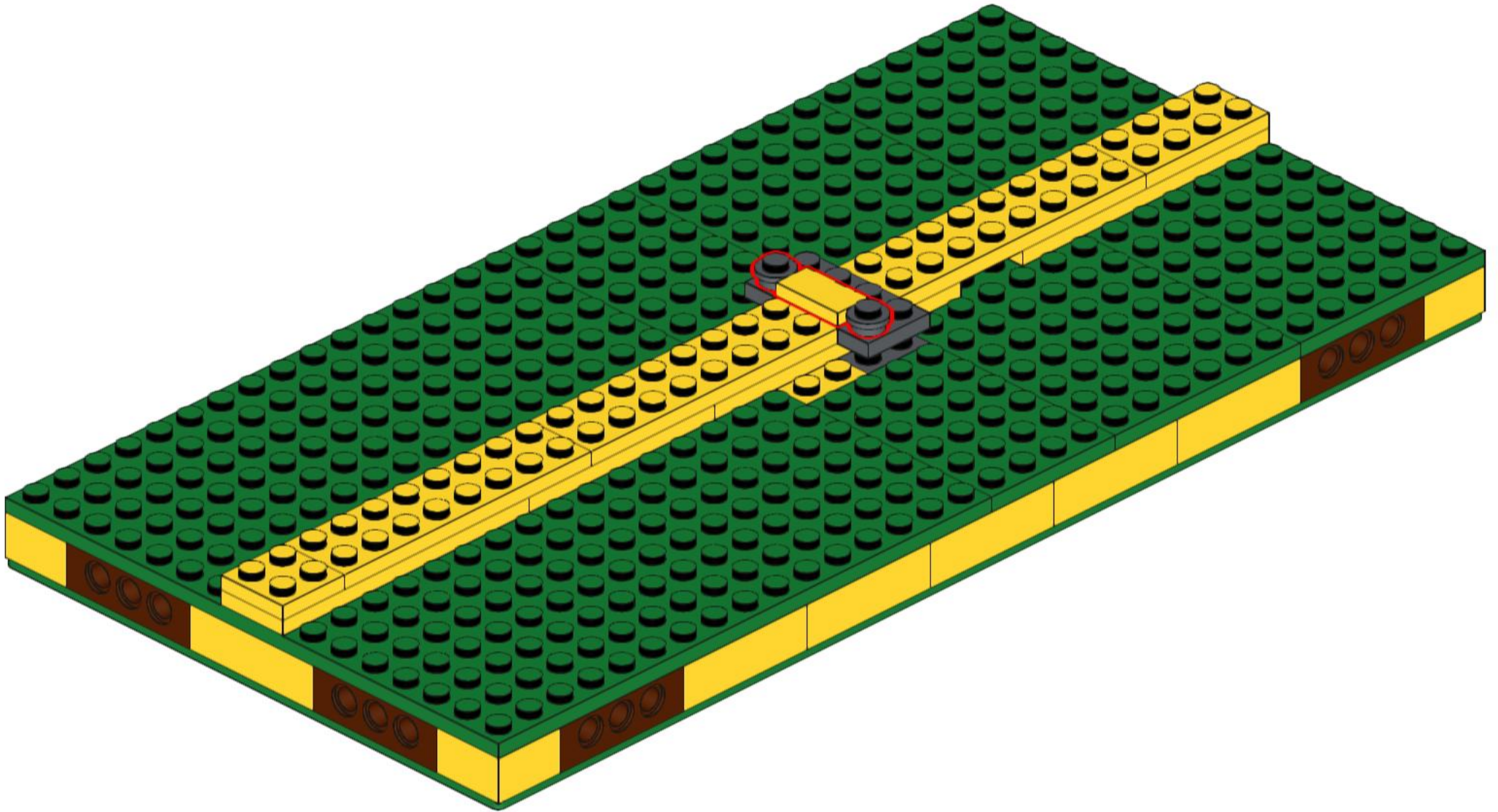
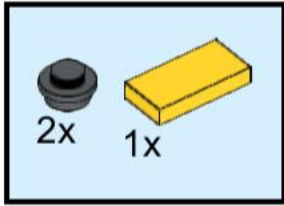

10

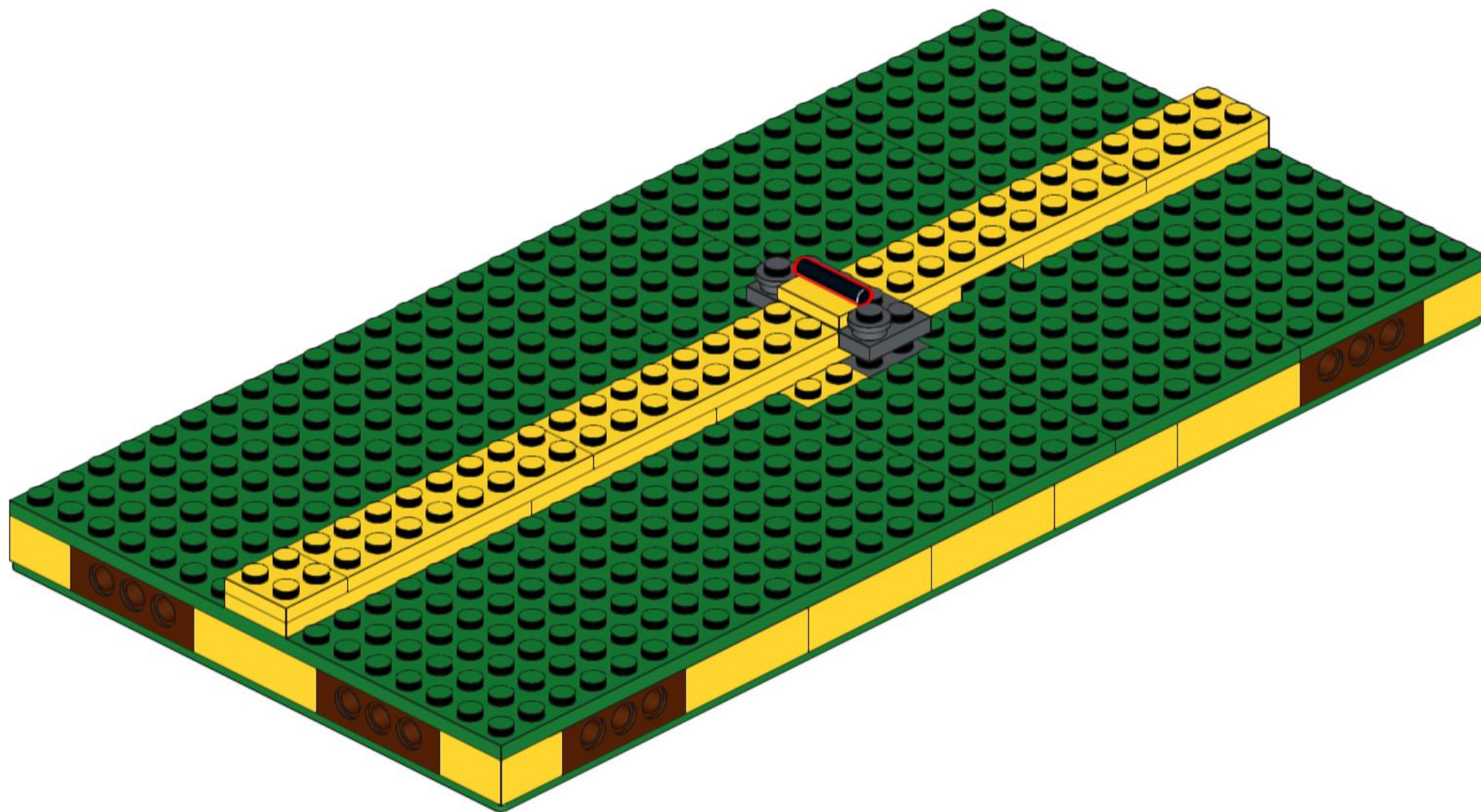

# 11

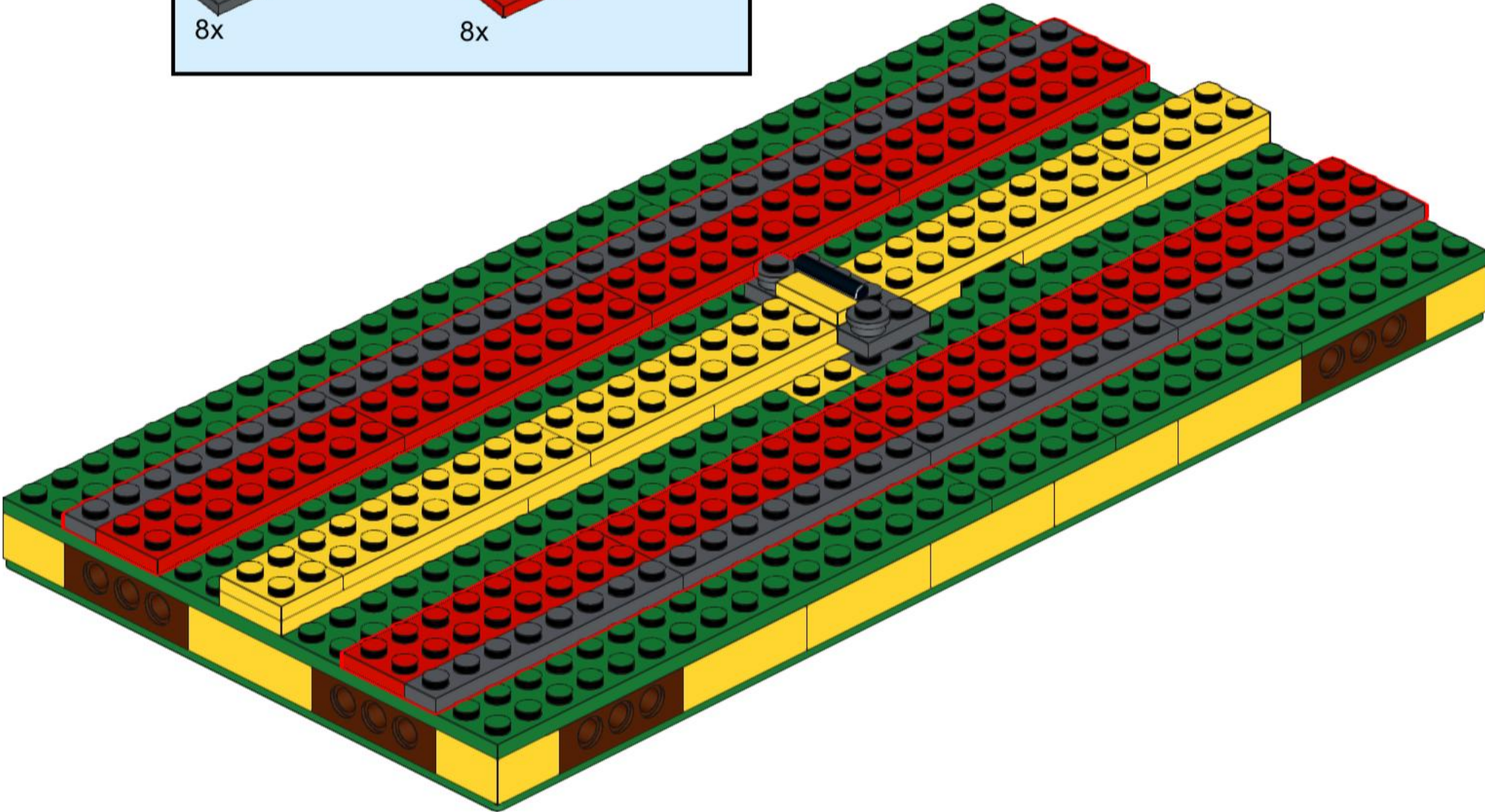
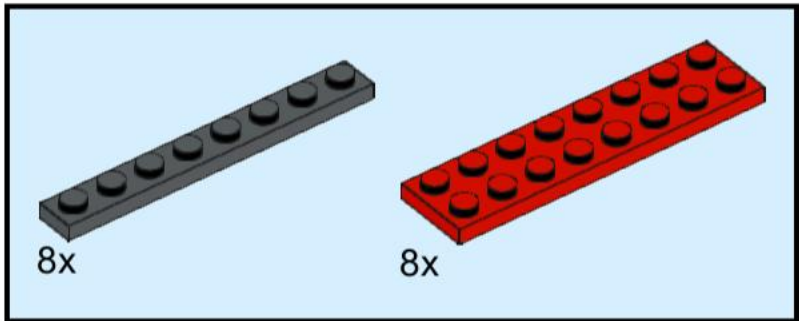

# 12

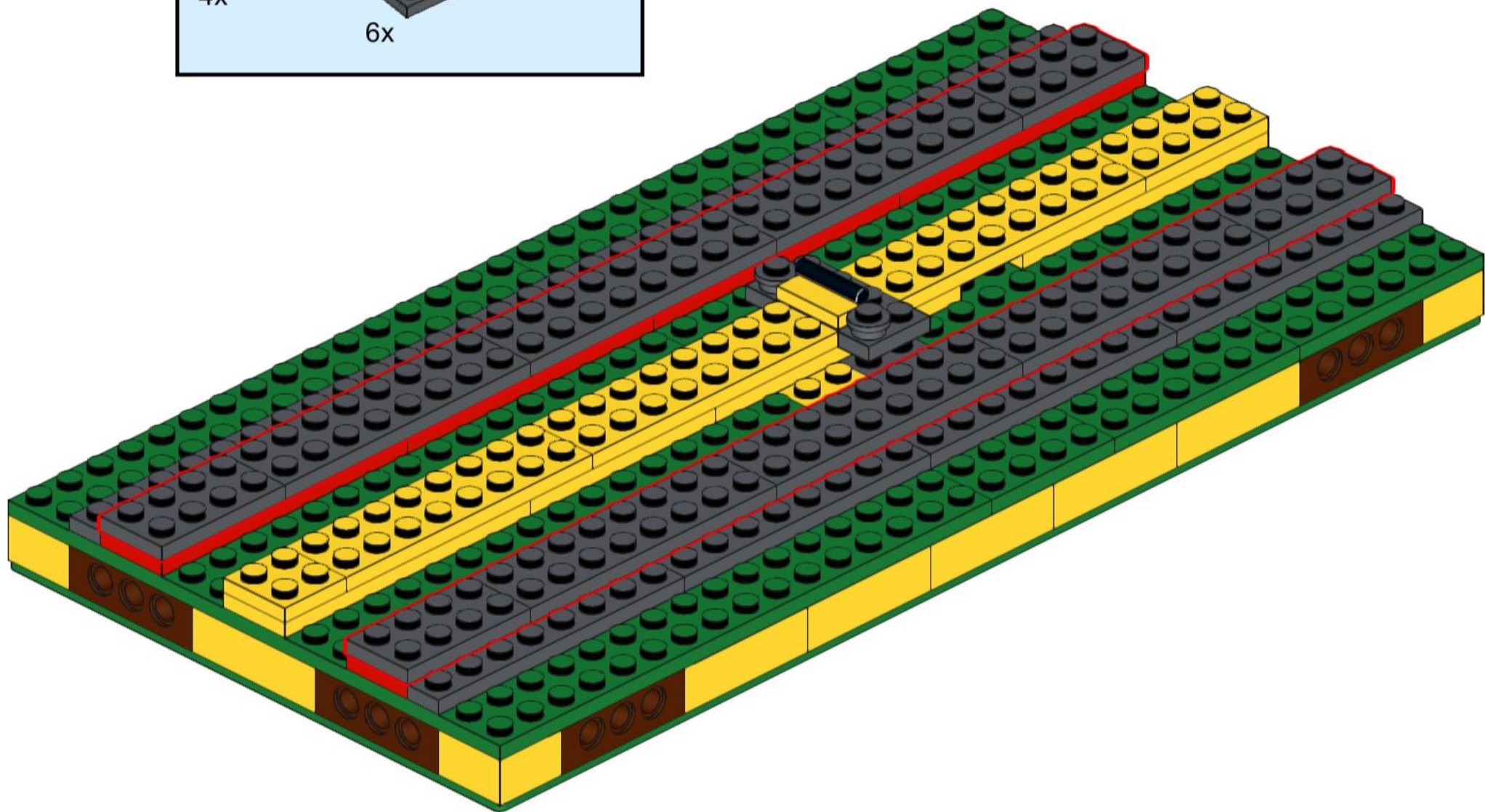
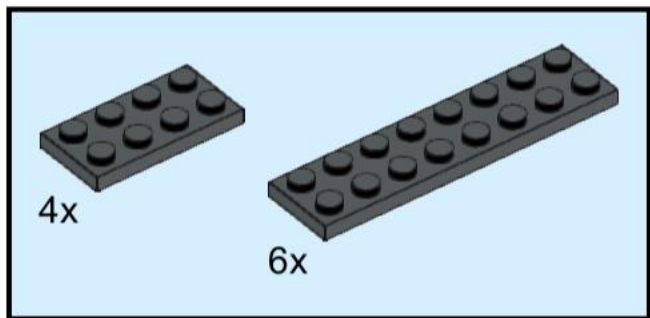

# 13

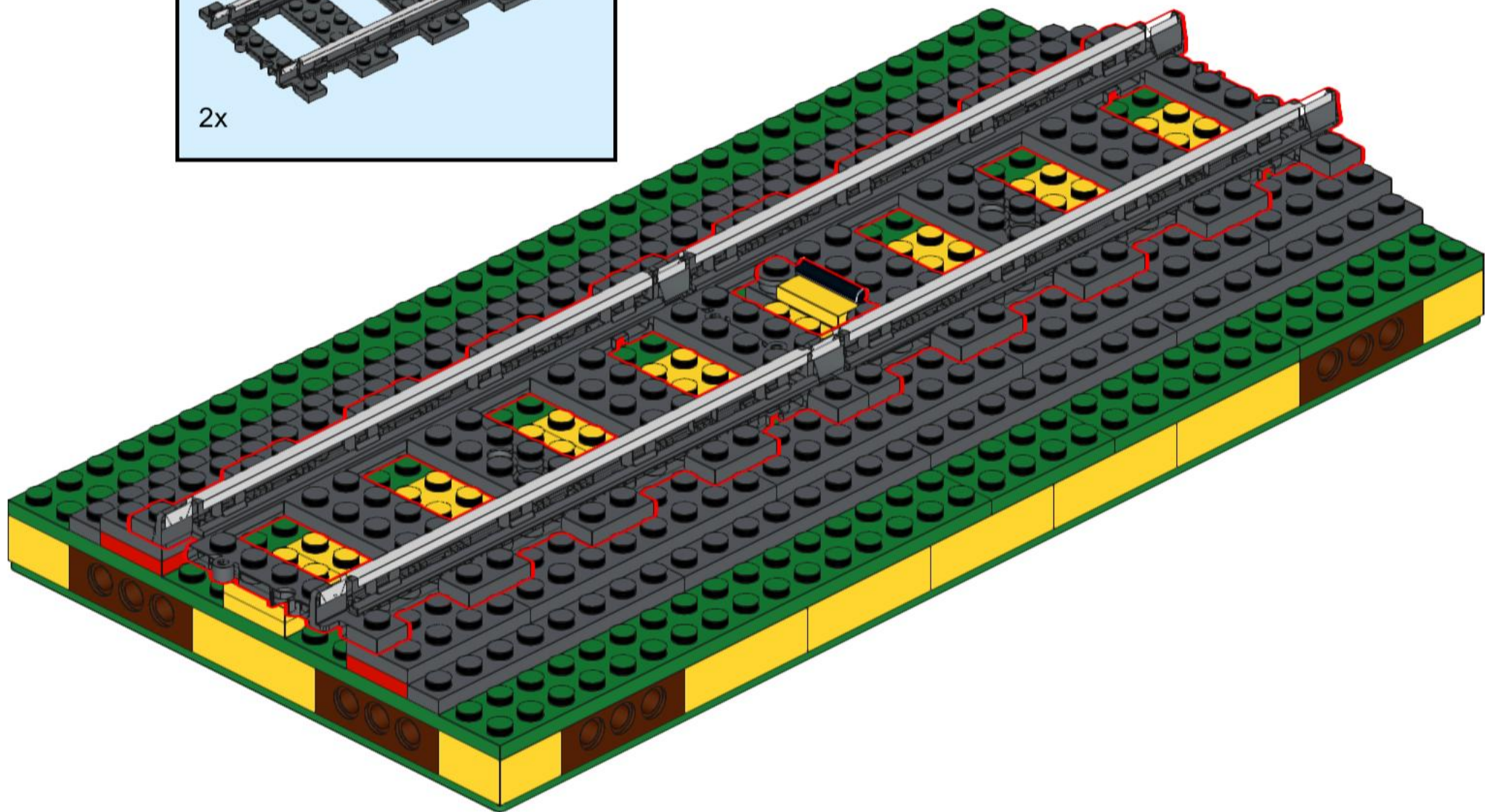
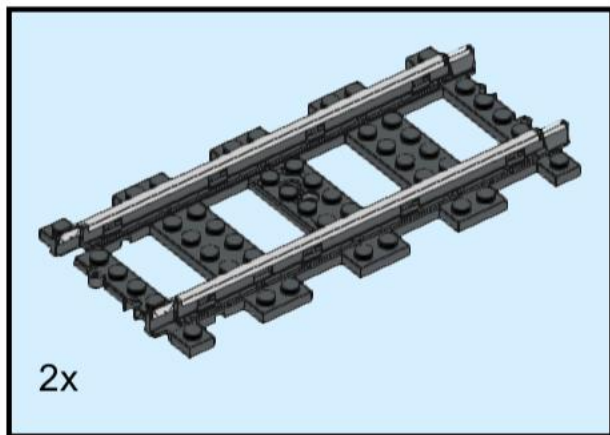

# 14

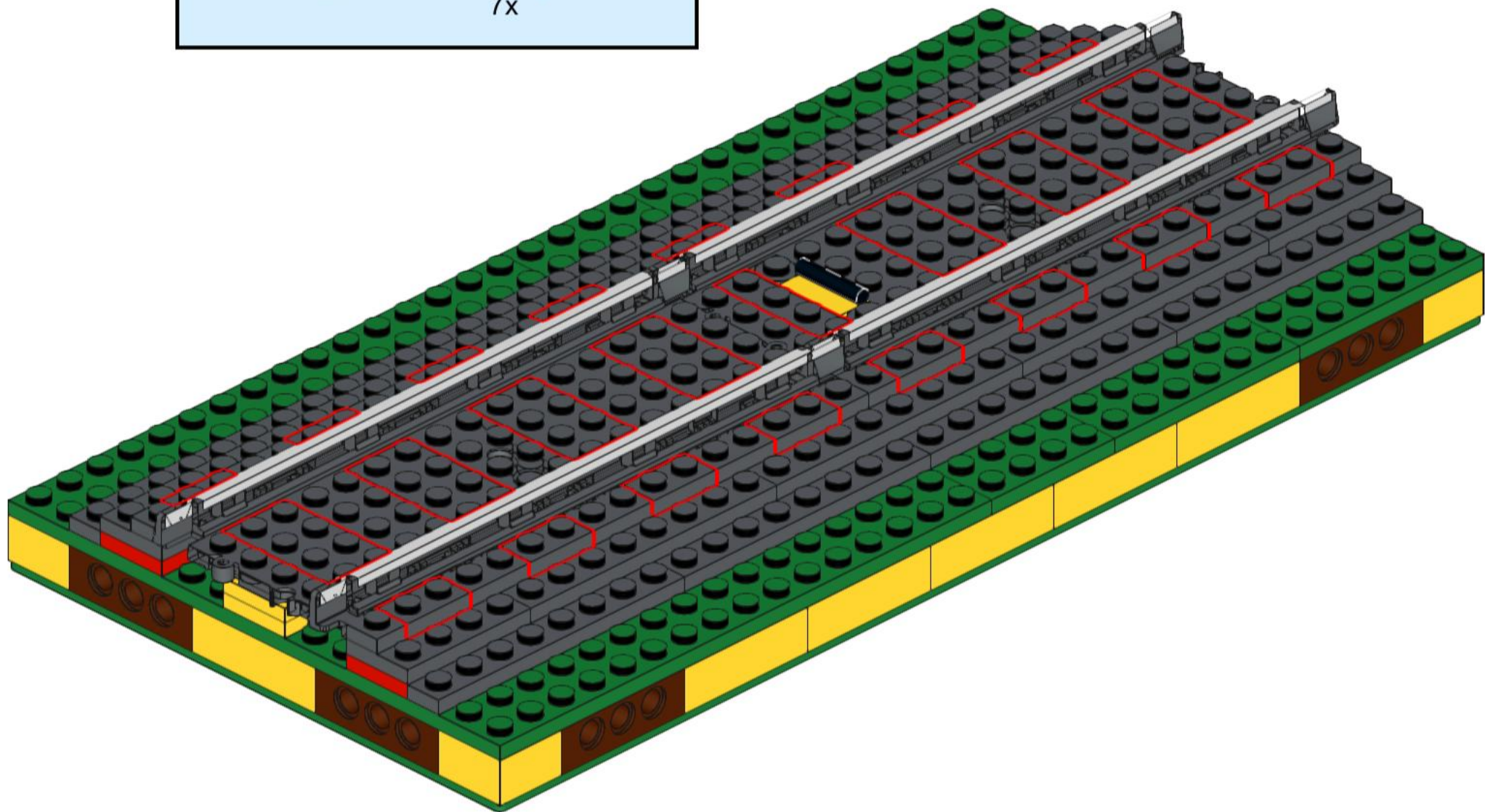
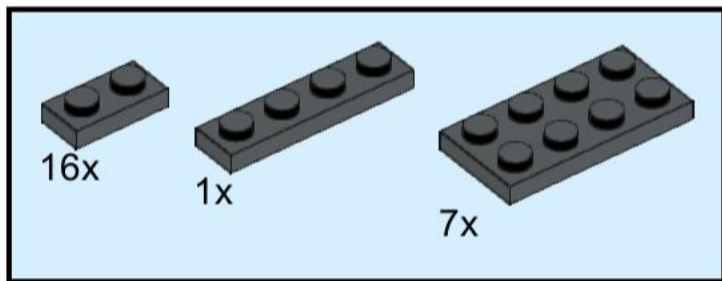

# 15

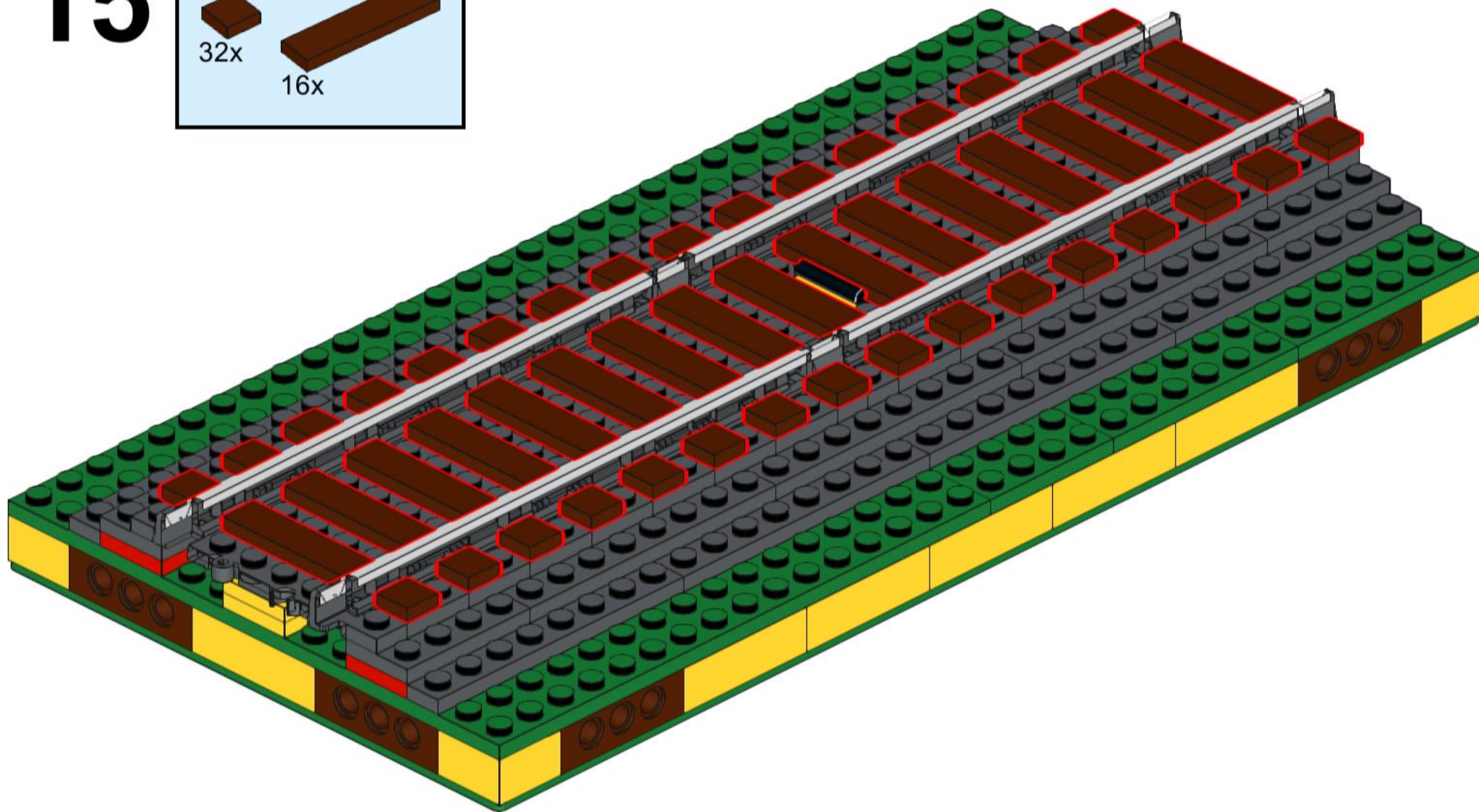
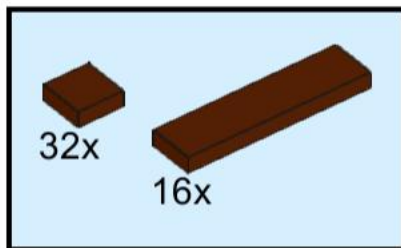



1x



8x  
3460  
Dark Bluish Gray



8x  
3701  
Reddish Brown



10x  
3001  
Yellow



1x  
91405  
Green

8x  
32064  
Black



6x  
3034  
Dark Bluish Gray



1x  
3069  
Yellow



1x  
3795  
Yellow



2x  
4073  
Dark Bluish Gray



2x  
2865c01  
Dark Bluish Gray



1x  
3022  
Yellow



6x  
3034  
Yellow

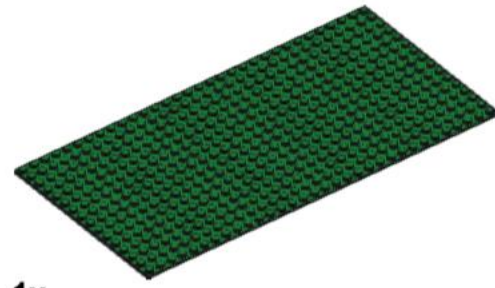
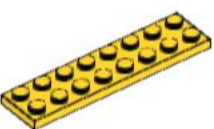

1x  
3857  
Green

16x  
3023  
Dark Bluish Gray



2x  
2865c01  
Dark Bluish Gray



8x  
3003  
Yellow



2x  
3032  
Green



1x  
3710  
Dark Bluish Gray



8x  
3034  
Red

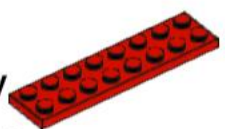

4x  
3010  
Yellow

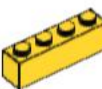

11x  
3020  
Dark Bluish Gray



32x  
3070  
Reddish Brown



2x  
3020  
Yellow



4x  
3036  
Green



2x  
3709b  
Dark Bluish Gray



16x  
2431  
Reddish Brown



Check out more information about LEGO track planning,  
LEGO train automation and more instructions on  
[www.mattzobricks.com](http://www.mattzobricks.com)

---

