

Dutch Railway Signal

Design by Mattzobricks
mattzobricks.com



Version 1.1

(c) 2022-2024 by Matthias Runte
All rights reserved
www.mattzobricks.com
info@mattzobricks.com

1

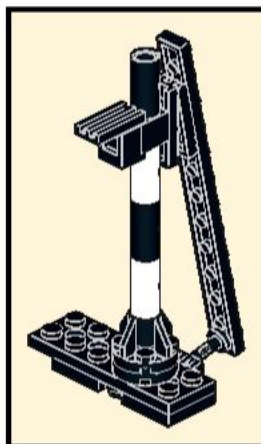
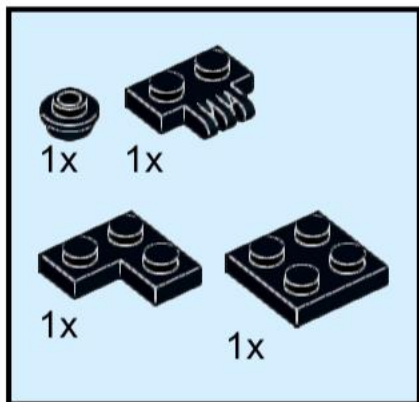

2

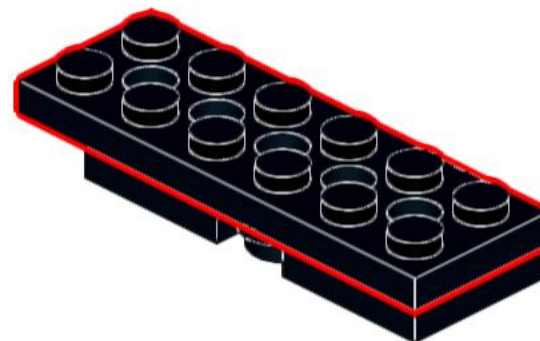
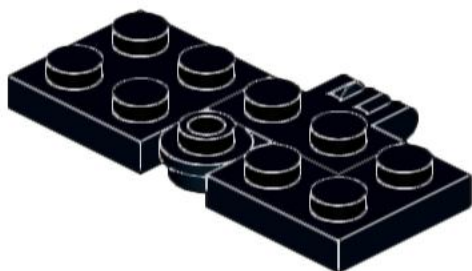
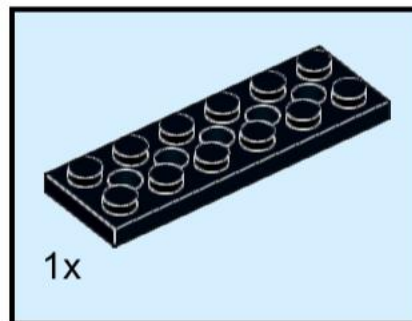

3

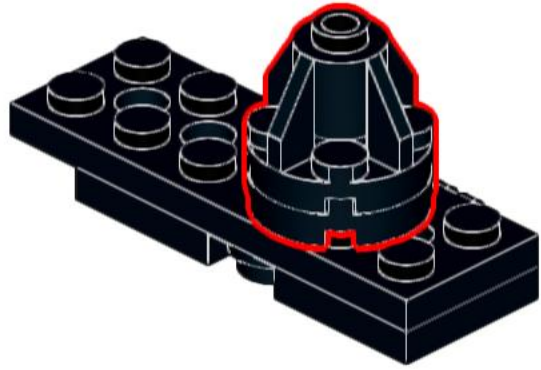
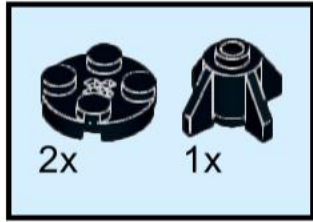

4

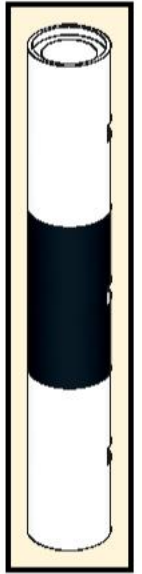
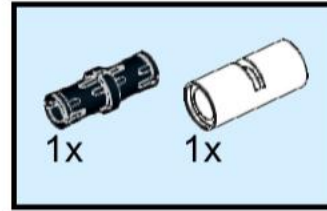

5

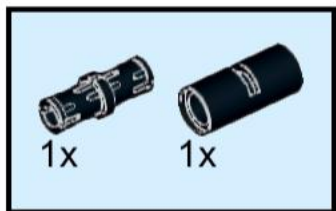

6

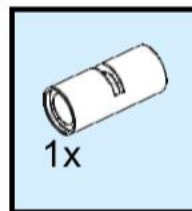

7

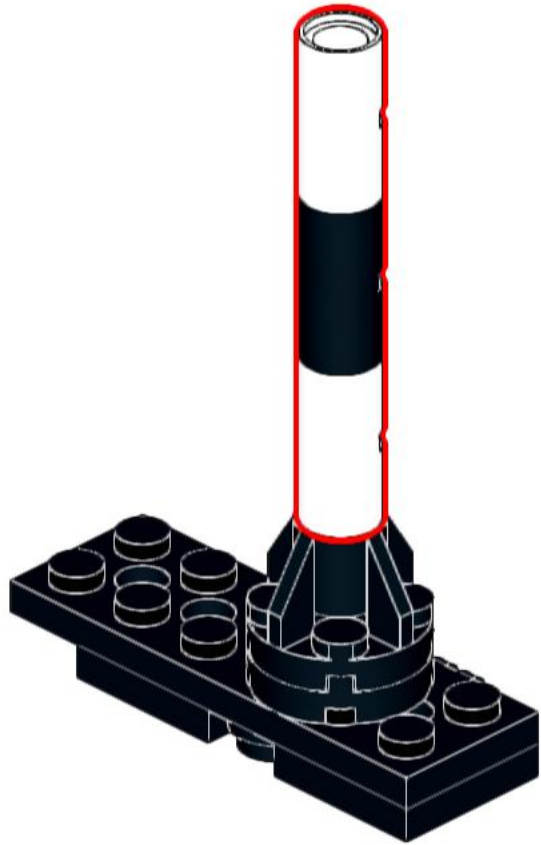

8

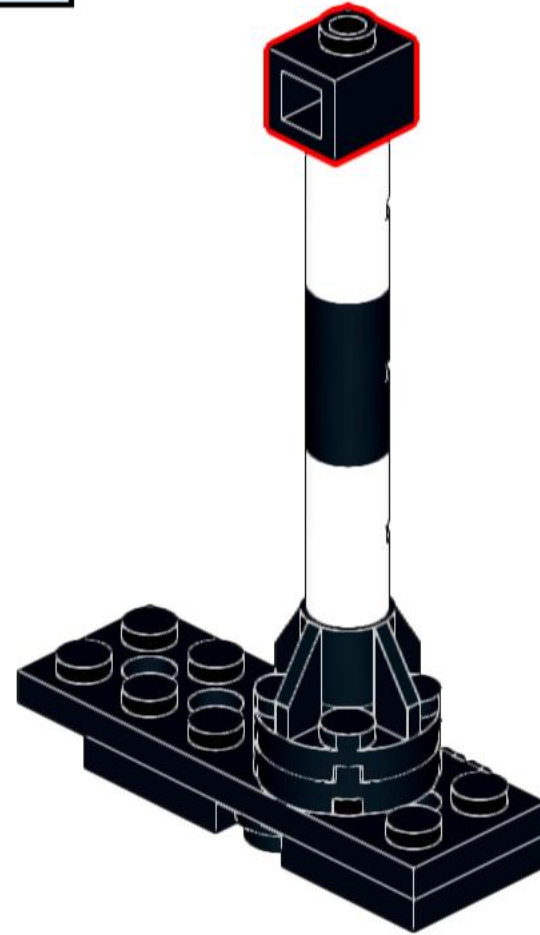
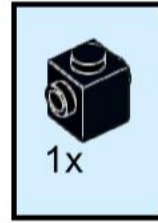

9

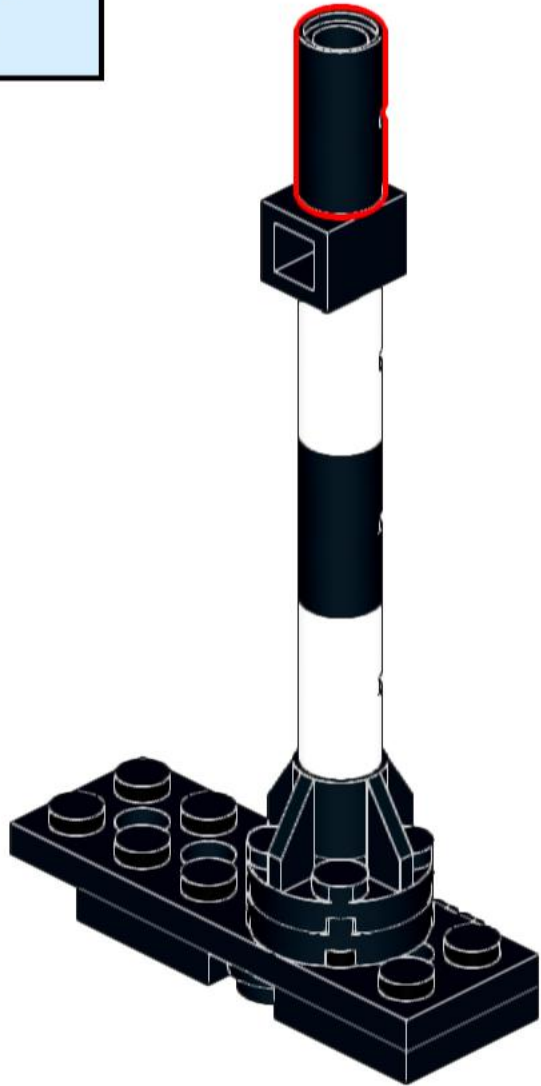

10

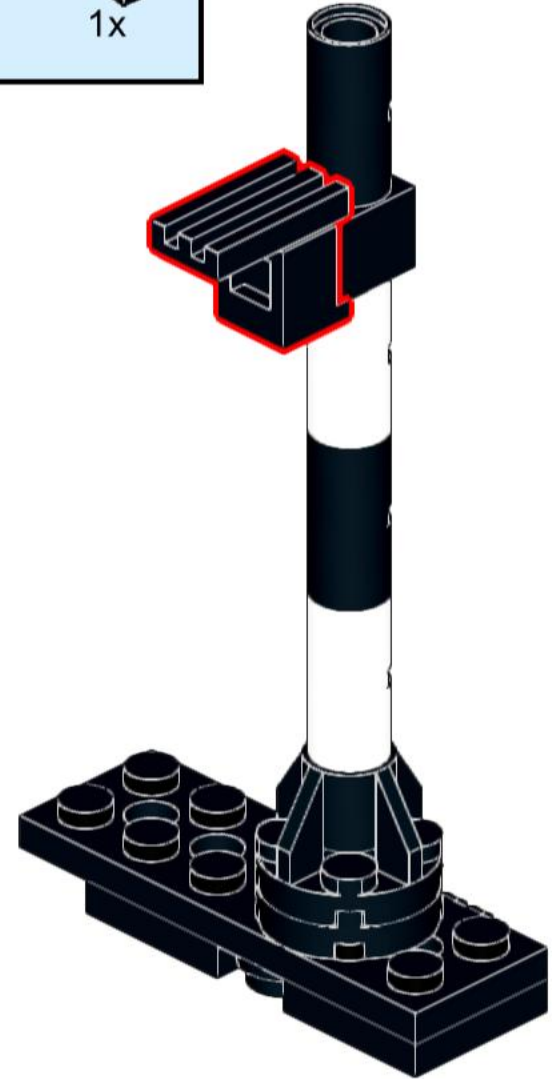
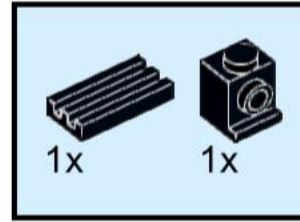

11

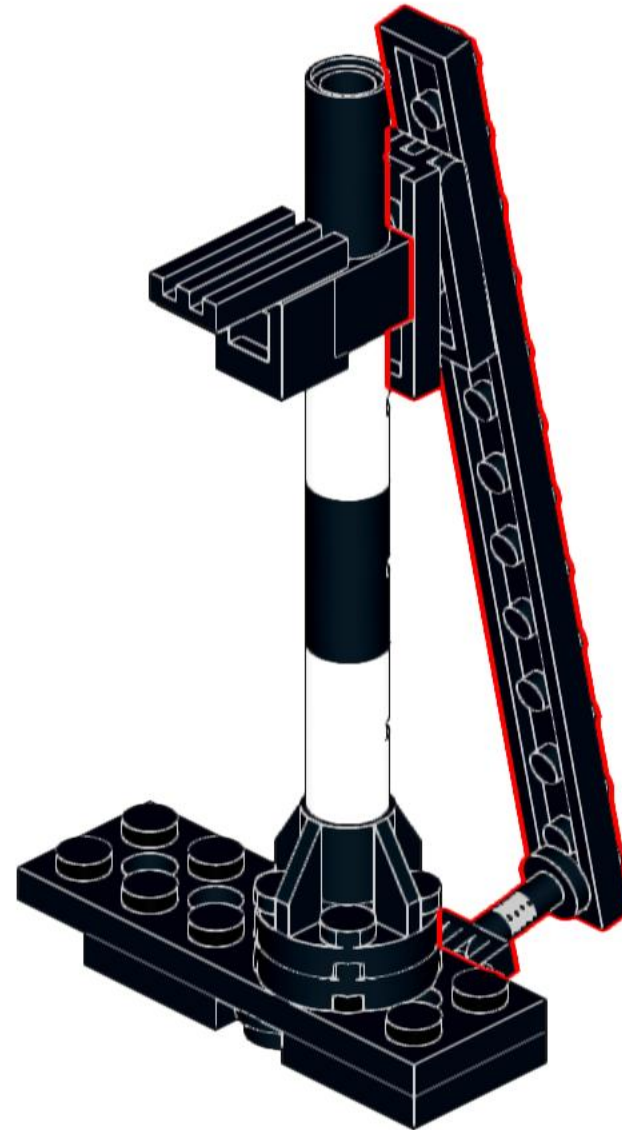
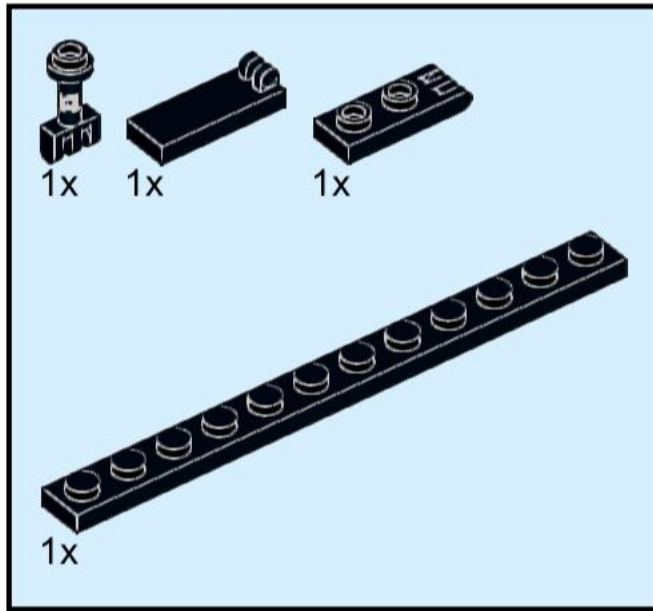

12

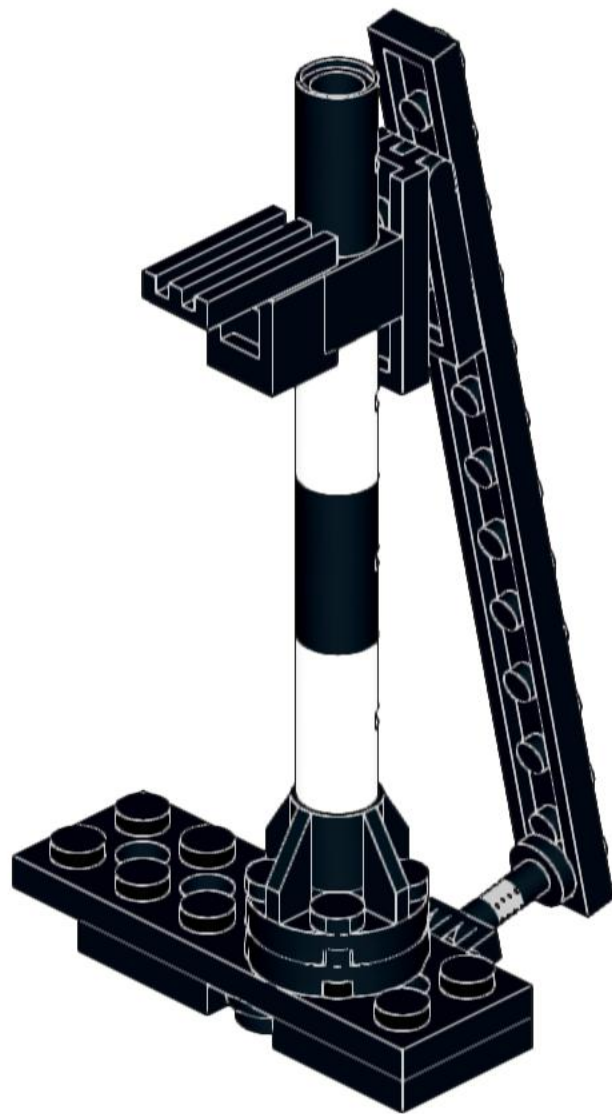

13

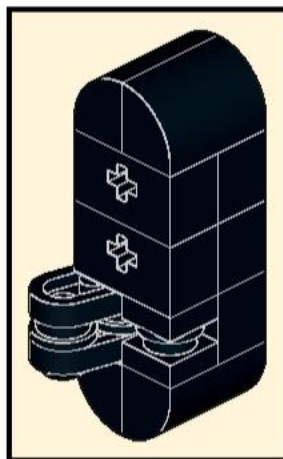
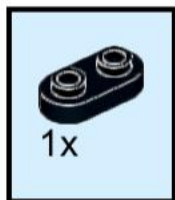

14



15

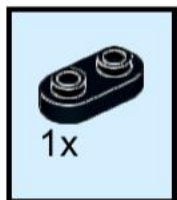

16



17

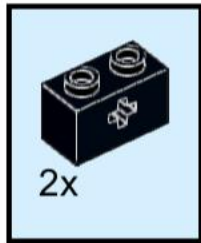

18



19

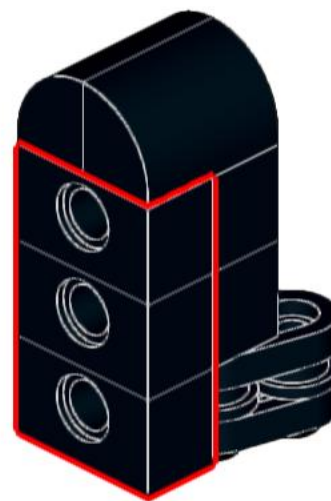
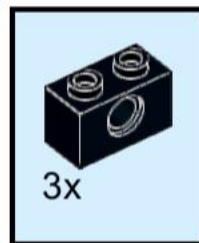

20

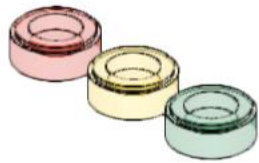
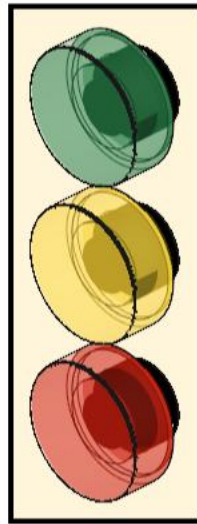
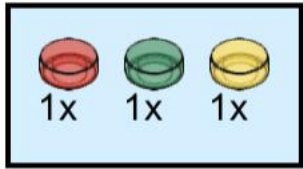

21

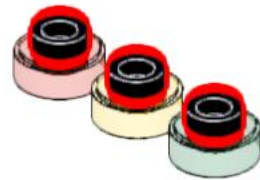

22

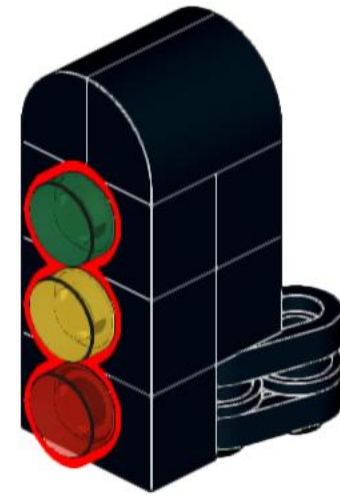

23

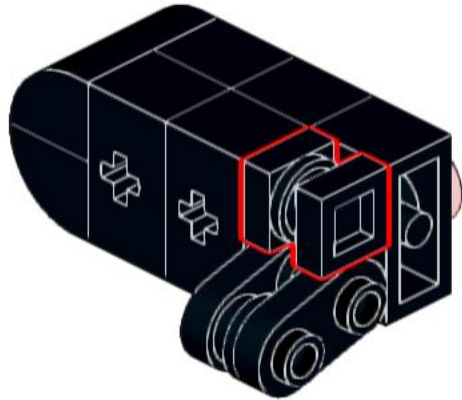
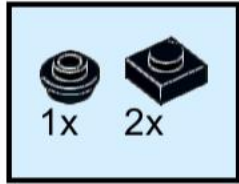

24

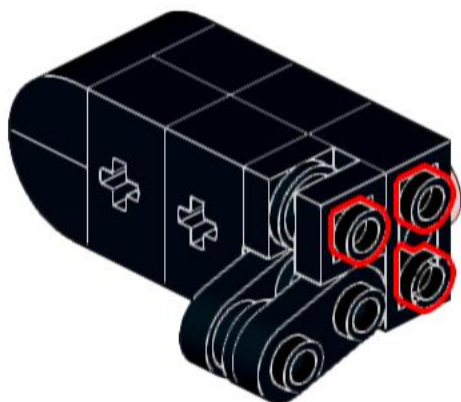

25

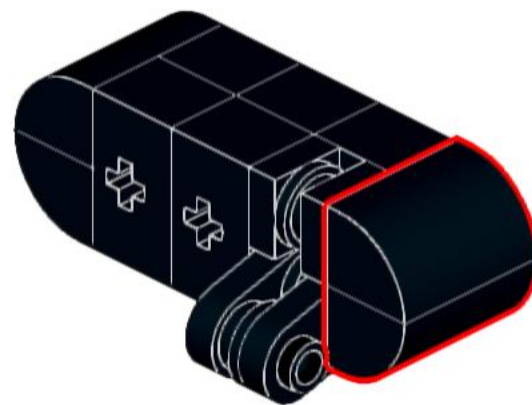
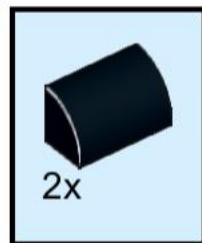

26

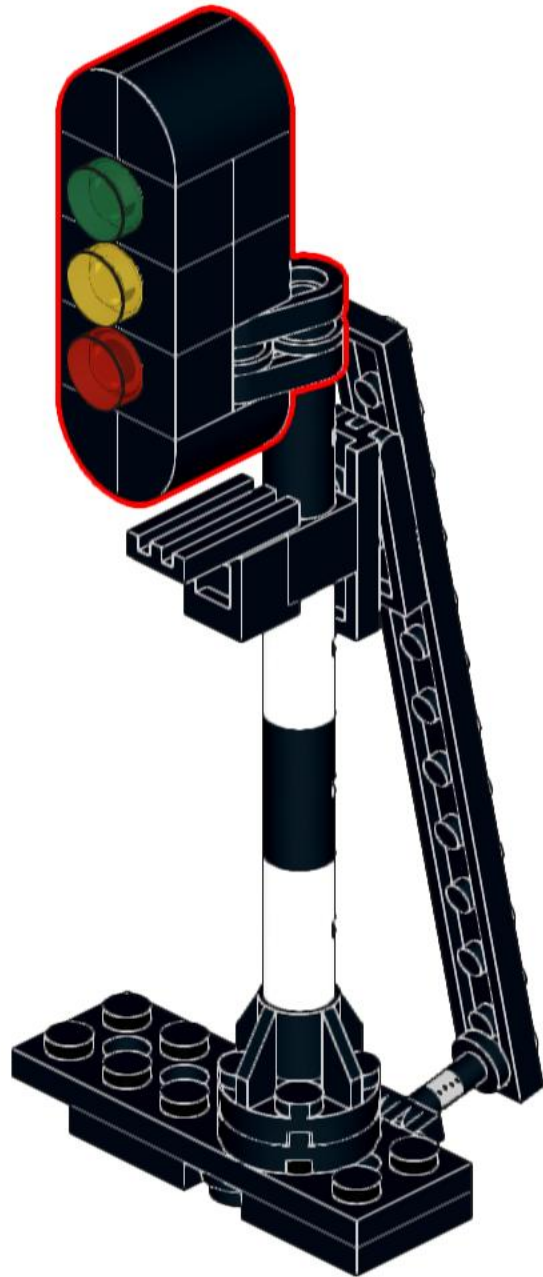

Check out information about LEGO track planning, LEGO train automation and more instructions on www.mattzobricks.com.

